

VIPA Accessories

Teleservice module | 900-2C610 | Manual

HB39E_TM | RE_900-2C610 | Rev. 13/28

July 2013

Copyright © VIPA GmbH. All Rights Reserved.

This document contains proprietary information of VIPA and is not to be disclosed or used except in accordance with applicable agreements.

This material is protected by the copyright laws. It may not be reproduced, distributed, or altered in any fashion by any entity (either internal or external to VIPA), except in accordance with applicable agreements, contracts or licensing, without the express written consent of VIPA and the business management owner of the material.

For permission to reproduce or distribute, please contact:
VIPA, Gesellschaft für Visualisierung und Prozessautomatisierung mbH
Ohmstraße 4, D-91074 Herzogenaurach, Germany
Tel.: +49 (91 32) 744 -0
Fax.: +49 9132 744 1864
EMail: info@vipa.de
<http://www.vipa.com>

Note

Every effort has been made to ensure that the information contained in this document was complete and accurate at the time of publishing. Nevertheless, the authors retain the right to modify the information. This customer document describes all the hardware units and functions known at the present time. Descriptions may be included for units which are not present at the customer site. The exact scope of delivery is described in the respective purchase contract.

CE Conformity Declaration

Hereby, VIPA GmbH declares that the products and systems are in compliance with the essential requirements and other relevant provisions.

Conformity is indicated by the CE marking affixed to the product.

Conformity Information

For more information regarding CE marking and Declaration of Conformity (DoC), please contact your local VIPA customer service organization.

Trademarks

VIPA, SLIO, System 100V, System 200V, System 300V, System 300S, System 400V, System 500S and Commander Compact are registered trademarks of VIPA Gesellschaft für Visualisierung und Prozessautomatisierung mbH.

SPEED7 is a registered trademark of profichip GmbH.

SIMATIC, STEP, SINEC, TIA Portal, S7-300 and S7-400 are registered trademarks of Siemens AG.

Microsoft und Windows are registered trademarks of Microsoft Inc., USA.

Portable Document Format (PDF) and Postscript are registered trademarks of Adobe Systems, Inc.

All other trademarks, logos and service or product marks specified herein are owned by their respective companies.

Information product support

Contact your local VIPA Customer Service Organization representative if you wish to report errors or questions regarding the contents of this document. If you are unable to locate a customer service center, contact VIPA as follows:

VIPA GmbH, Ohmstraße 4, 91074 Herzogenaurach, Germany

Telefax: +49 9132 744 1204
EMail: documentation@vipa.de

Technical support

Contact your local VIPA Customer Service Organization representative if you encounter problems with the product or have questions regarding the product. If you are unable to locate a customer service center, contact VIPA as follows:

VIPA GmbH, Ohmstraße 4, 91074 Herzogenaurach, Germany

Telephone: +49 9132 744 1150 (Hotline)
EMail: support@vipa.de

Contents

About this manual	1
Safety information	2
Chapter 1 Assembly and installation guidelines.....	1-1
Safety information for Users	1-2
Installation dimensions	1-3
Assembly.....	1-4
Cabling.....	1-6
Installation guidelines	1-7
Chapter 2 Hardware description	2-1
Properties.....	2-2
Structure	2-3
Technical Data	2-8
Chapter 3 Deployment	3-1
Fast introduction.....	3-2
Assembly.....	3-5
Cabling.....	3-6
TM - Configuration - eBuddy	3-7
TM - Reset	3-13
TM - Web page	3-14
TM - PLC linking.....	3-15
TM - Project integration - PG/PC interface via NetPro.....	3-18
TM - Project integration - PG/PC interface via eVCOM	3-23
VPN connection - Talk2M.....	3-25
VPN connection - PC-Talk2M.....	3-27
VPN connection - TM-Talk2M via DSL/LAN	3-31

About this manual

Important note! The information in this manual should simplify you the deployment of remote controlling VIPA PLCs. More information concerning this may be found in German and English at:

support.ewon.biz
www.ewon-online.de

This Teleservice module (TM-C) from VIPA is constructed in the same way as the module "eWON COSY WEC51460".

Overview

Chapter 1: Assembly and installation guidelines

In this chapter you will find all information, required for assembly and installation of the Teleservice module (TM).

Chapter 2: Hardware description

Here the hardware components of the Teleservice module (TM) are more described.

The technical data are at the end of this chapter.

Chapter 3: Deployment

This chapter concerns on the deployment of the Teleservice module (TM) from VIPA with a PLC. With the fast introduction you will get an overview about the possibilities of teleservice. Another part of this chapter is the configuration of the TM by means of the integrated Web page.

The chapter is continued with the possibilities to the PLC connection.

Its finished with the description of the communication via VPN.

Objective and contents

This manual describes the Teleservice module TM-C Router VPN from VIPA. It contains a description of the construction, project implementation and usage.

This manual is part of the documentation package with order number VIPA HB39E_TM and relevant for:

Product	Order number	as of state: TM-FW
TM-C Router	VIPA 900-2C610	5.6

Target audience

The manual is targeted at users who have a background in automation technology.

Structure of the manual

The manual consists of chapters. Every chapter provides a self-contained description of a specific topic.

Guide to the document

The following guides are available in the manual:

- an overall table of contents at the beginning of the manual
- an overview of the topics for every chapter
- an index at the end of the manual.

Availability

The manual is available in:

- printed form, on paper
- in electronic form as PDF-file (Adobe Acrobat Reader)

Icons Headings

Important passages in the text are highlighted by following icons and headings:

**Danger!**

Immediate or likely danger.
Personal injury is possible.

**Attention!**

Damages to property is likely if these warnings are not heeded.

**Note!**

Supplementary information and useful tips

Safety information

Applications conforming with specifications

The Teleservice module is constructed and produced for:

- communication and process control
- general control and automation applications
- industrial applications
- operation within the environmental conditions specified in the technical data
- installation into a cubicle



Danger!

This device is not certified for applications in

- in explosive environments (EX-zone)

Documentation

The manual must be available to all personnel in the

- project design department
- installation department
- commissioning
- operation



The following conditions must be met before using or commissioning the components described in this manual:

- Modification to the process control system should only be carried out when the system has been disconnected from power!
- Installation and modifications only by properly trained personnel
- The national rules and regulations of the respective country must be satisfied (installation, safety, EMC ...)

Disposal

National rules and regulations apply to the disposal of the unit!

Chapter 1 Assembly and installation guidelines

Overview In this chapter you will find all information, required for assembly and installation of the Teleservice module (TM).

Content	Topic	Page
	Chapter 1 Assembly and installation guidelines.....	1-1
	Safety information for Users.....	1-2
	Installation dimensions	1-3
	Assembly.....	1-4
	Cabling.....	1-6
	Installation guidelines	1-7

Safety information for Users

Handling of electrostatic sensitive modules

VIPA modules make use of highly integrated components in MOS-Technology. These components are extremely sensitive to over-voltages that can occur during electrostatic discharges.

The following symbol is attached to modules that can be destroyed by electrostatic discharges.



The Symbol is located on the module, the module rack or on packing material and it indicates the presence of electrostatic sensitive equipment.

It is possible that electrostatic sensitive equipment is destroyed by energies and voltages that are far less than the human threshold of perception. These voltages can occur where persons do not discharge themselves before handling electrostatic sensitive modules and they can damage components thereby, causing the module to become inoperable or unusable.

Modules that have been damaged by electrostatic discharges can fail after a temperature change, mechanical shock or changes in the electrical load.

Only the consequent implementation of protection devices and meticulous attention to the applicable rules and regulations for handling the respective equipment can prevent failures of electrostatic sensitive modules.

Shipping of electrostatic sensitive modules

Modules must be shipped in the original packing material.

Measurements and alterations on electrostatic sensitive modules

When you are conducting measurements on electrostatic sensitive modules you should take the following precautions:

- Floating instruments must be discharged before use.
- Instruments must be grounded.

Modifying electrostatic sensitive modules you should only use soldering irons with grounded tips.



Attention!

Personnel and instruments should be grounded when working on electrostatic sensitive modules.

Installation dimensions

Dimensions

Make sure that a clearance of at least 100mm exists above and 70mm below the middle of the bus rail.

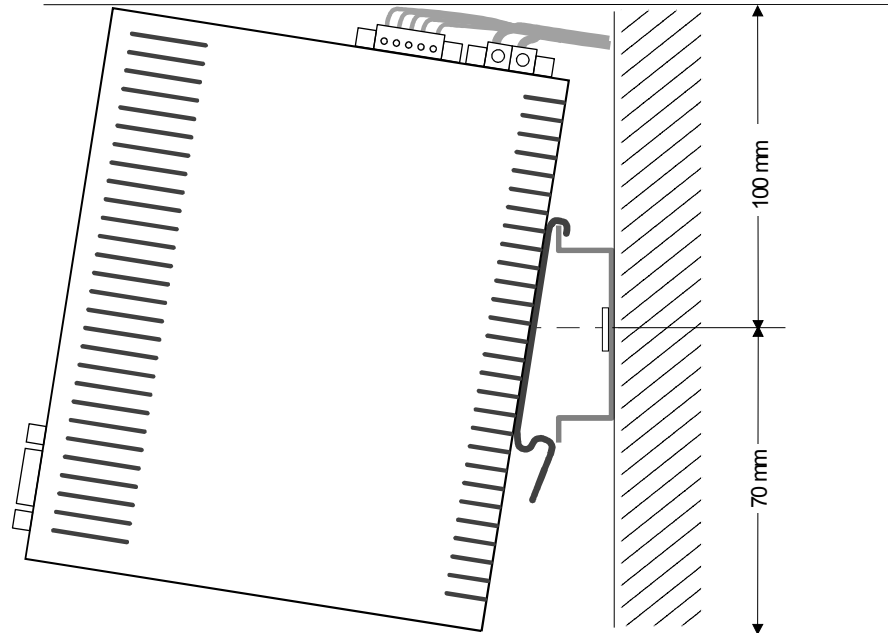

Dimensions assembled

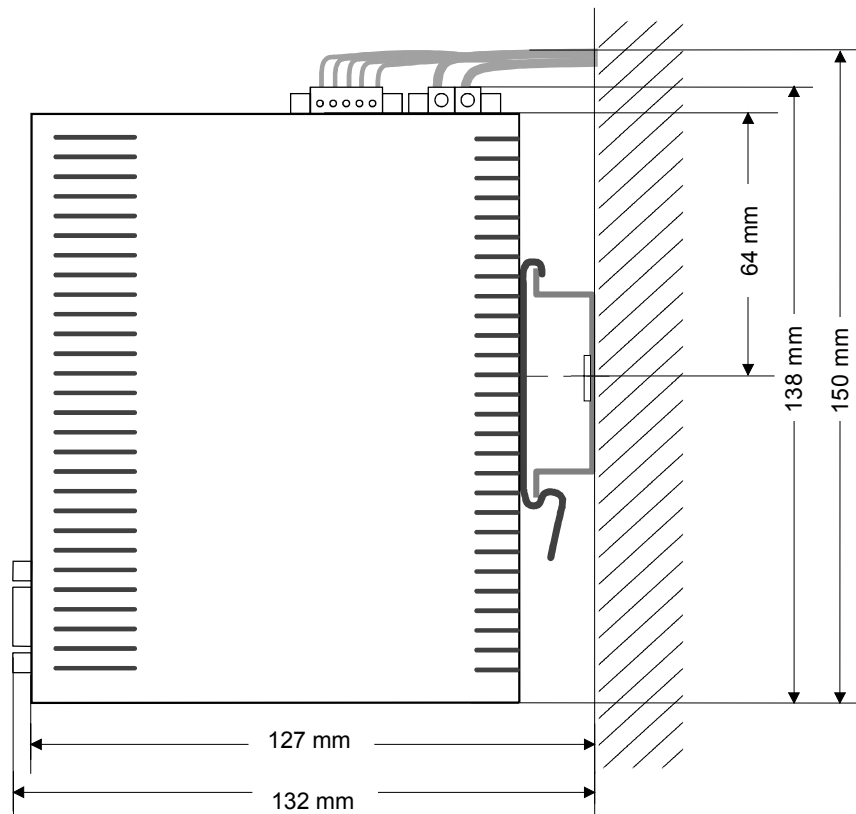

Assembly

General

The modules are installed on a profile rail. You may use the following standard 35mm profile rail:

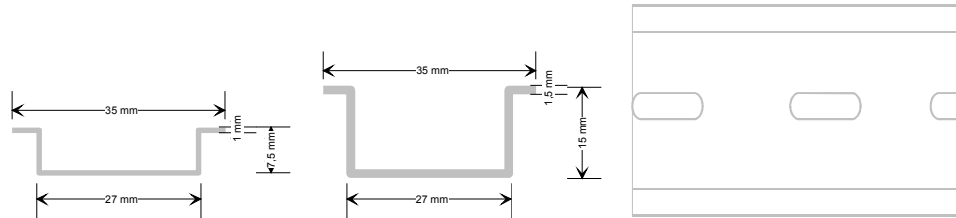

Assembly procedure

The following sequence represents the assembly procedure as viewed from the side.

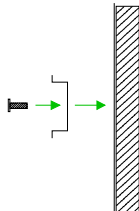

- Install the profile rail. Make sure that a clearance of at least 100mm exists above and 70mm below the middle of the profile rail.

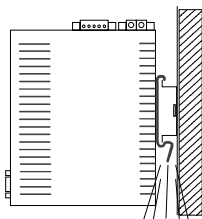
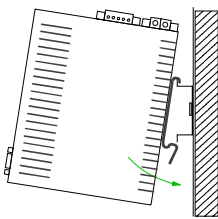
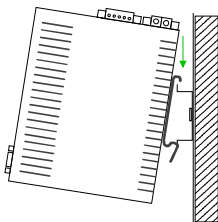

Click

- Insert the module that you are installing into the profile rail at an angle of about 45 degrees from the top and rotate the module into place until it clicks into the profile rail with an audible click.

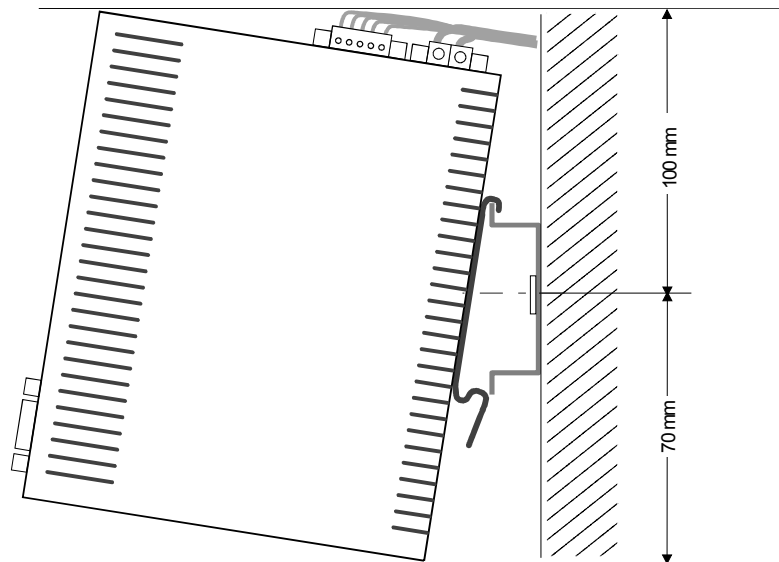

Removal procedure

The following sequence shows the steps required for the removal of modules in a side view.

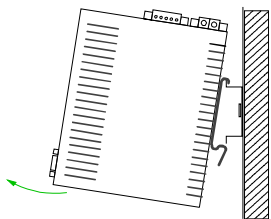

- For the removal take the module at the bottom and pull it forward with a strong jerk.

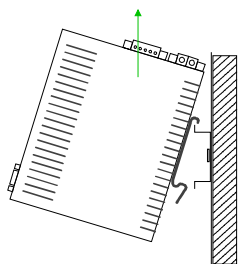

- Now withdraw the module with a slight rotation to the top.

Cabling

Overview

At the upper side of the Teleservice module there are connectors for power supply and digital inputs/outputs. The output is designed as low-side output and may be configured.

The connectors are plugs with screw contacts. If connected the plugs may be fixed with screws.

The I/Os are controlled by *Tags*. An example may be found at the chapter "Deployment" at "Deployment of Tags".

Power supply

The Teleservice module is to be supplied by DC 12...24V ±20%.

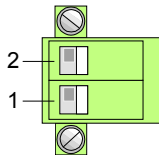

Pin	Name	Meaning
2	12-24V DC	DC 12 ... 24V ±20%
1	GND	Ground power supply

DI/DO connection

The output is designed as low-side output and may be configured.

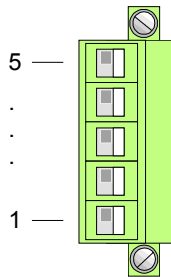

Pin	Name	Meaning
5	DI	Digital input DC 0/24V "0": 0 ... 5V DC "1": 10V ... 30V DC
4	DI_GND	DI ground (isolated)
3	DO_VDC	DO load voltage DC 24V
2	DO	Digital output DC 24V, 0.2A Low-side output
1	DO_GND	DO ground

DI/DO wiring schematic diagram

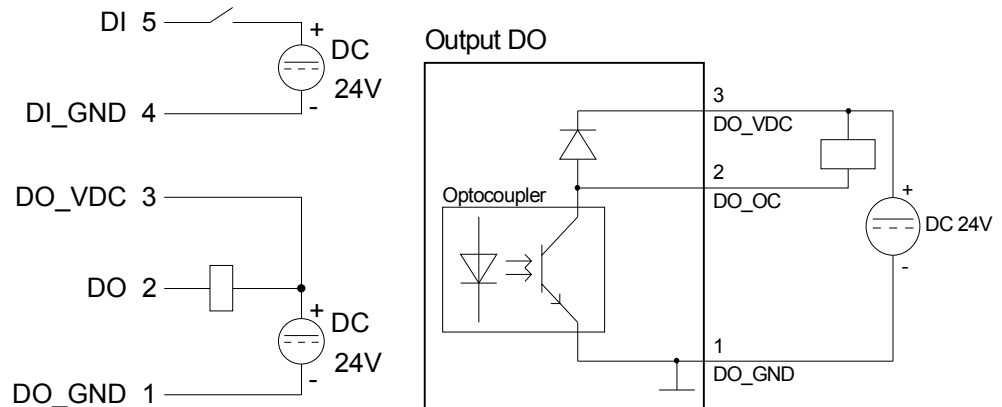

Installation guidelines

General

The installation guidelines contain information about the possible interference causes. Here we describe possible ways of interference that may disturb the controlling system and how you have to approach shielding and screening issues to ensure the electromagnetic compatibility (EMC).

What is EMC?

Electromagnetic digestibility (EMC) means the ability of an electrical device, to function error free in an electromagnetic environment without being interferenced res. without interfering the environment.

The Teleservice module is developed for applications in harsh industrial environments and they comply with EMC requirements to a large degree. In spite of this you should implement an EMC strategy before installing your SPS and the Teleservice module, which should include any possible source of interference.

Possible interference causes

Electromagnetic interferences may interfere your control via different ways:

- Fields
- I/O signal conductors
- Bus system
- Current supply
- Protected earth conductor

Depending on the spreading medium (lead bound or lead free) and the distance to the interference cause, interferences to your control occur by means of different coupling mechanisms.

One differs:

- galvanic coupling
- capacitive coupling
- inductive coupling
- radiant coupling

Basic rules for EMC

In the most times it is enough to take care of some elementary rules to guarantee the EMC. Please regard the following basic rules when installing your PLC.

- Take care of a correct area-wide grounding of the inactive metal parts when installing your components.
 - Install a central connection between the ground and the protected earth conductor system.
 - Connect all inactive metal extensive and impedance-low.
 - Please try not to use aluminum parts. Aluminum is easily oxidizing and is therefore less suitable for grounding.
- When cabling, take care of the correct line routing.
 - Organize your cabling in line groups (high voltage, current supply, signal and data lines).
 - Always lay your high voltage lines and signal res. data lines in separate channels or bundles.
 - Route the signal and data lines as near as possible beside ground areas (e.g. suspension bars, metal rails, tin cabinet).
- Proof the correct fixing of the lead isolation.
 - Data lines must be laid isolated.
 - Analog lines must be laid isolated. When transmitting signals with small amplitudes the one sided laying of the isolation may be favorable.
 - Lay the line isolation extensively on an isolation/protected earth conductor rail directly after the cabinet entry and fix the isolation with cable clamps.
 - Make sure that the isolation/protected earth conductor rail is connected impedance-low with the cabinet.
 - Use metallic or metalized plug cases for isolated data lines.
- In special use cases you should appoint special EMC actions.
 - Wire all inductivities with erase links, which are addressed by your PLC.
 - For lightening cabinets you should prefer incandescent lamps and avoid luminescent lamps.
- Create a homogeneous reference potential and ground all electrical operating supplies when possible.
 - Please take care for the targeted employment of the grounding actions. The grounding of the PLC is a protection and functionality activity.
 - Connect installation parts and cabinets with your PLC in star topology with the isolation/protected earth conductor system. So you avoid ground loops.
 - If potential differences between installation parts and cabinets occur, lay sufficiently dimensioned potential compensation lines.

Isolation of conductors

Electrical, magnetic and electromagnetic interference fields are weakened by means of an isolation, one talks of absorption.

Via the isolation rail, that is connected conductive with the rack, interference currents are shunt via cable isolation to the ground. Hereby you have to make sure, that the connection to the protected earth conductor is impedance-low, because otherwise the interference currents may appear as interference cause.

When isolating cables you have to regard the following:

- If possible, use only cables with isolation tangle.
- The hiding power of the isolation should be higher than 80%.
- Normally you should always lay the isolation of cables on both sides. Only by means of the both-sided connection of the isolation you achieve high quality interference suppression in the higher frequency area.
Only as exception you may also lay the isolation one-sided. Then you only achieve the absorption of the lower frequencies. A one-sided isolation connection may be convenient, if:
 - the conduction of a potential compensating line is not possible
 - analog signals (some mV res. μA) are transferred
 - foil isolations (static isolations) are used.
- With data lines always use metallic or metalized plugs for serial couplings. Fix the isolation of the data line at the plug rack. Do not lay the isolation on the PIN 1 of the plug bar!
- At stationary operation it is convenient to strip the insulated cable interruption free and lay it on the isolation/protected earth conductor line.
- To fix the isolation tangles use cable clamps out of metal. The clamps must clasp the isolation extensively and have well contact.
- Lay the isolation on an isolation rail directly after the entry of the cable in the cabinet. Lead the isolation further on to the PLC and **don't** lay it on there again!

**Please regard at installation!**

At potential differences between the grounding points, there may be a compensation current via the isolation connected at both sides.

Remedy: Potential compensation line

Chapter 2 Hardware description

Overview Here the hardware components of the Teleservice module (TM) are more described.
The technical data are at the end of this chapter.

Content	Topic	Page
	Chapter 2 Hardware description	2-1
	Properties	2-2
	Structure	2-3
	Technical Data	2-8

Properties

Overview

The TM-C is an intelligent teleservice module with integrated broadband router. This module makes simple and safe communication with your machines and plants possible via a DSL connection or in the local network. Values of your plant may be observed and appropriate reactions to limit exceeds may be configured. Due to the integrated Web page, for configuration there is no additional software necessary.

Due to the predefined server the embedding to a VIPA PLC may be established problem-free. The TM may be integrated as PG/OP interface to the Siemens SIMATIC manager by means of a station file.

Properties

- 4port Ethernet switch for LAN machine network
- 1port Ethernet WAN for LAN factory network
- Broadband router in a compact design
- Sending alarms by eMail and SMS (only via free SMS provider)
- up to 20 Ethernet sessions simultaneous
- RS485 MPI/PROFIBUS DP interface

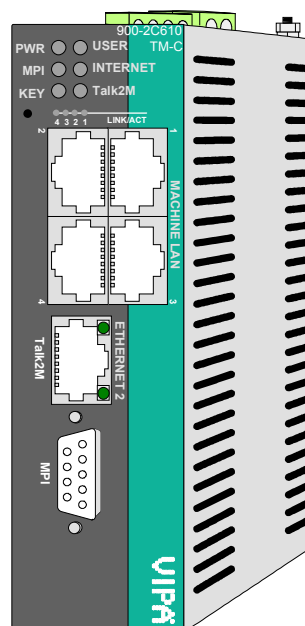

Order data

Type	Order number	Description
TM-C Router	VIPA 900-2C610	DC 12 ... 24V, MPI, 5xEthernet RJ45, Router functions, DI 1xDC 24V, DO 1xDC 24V 0.2A

Structure

TM-C Router

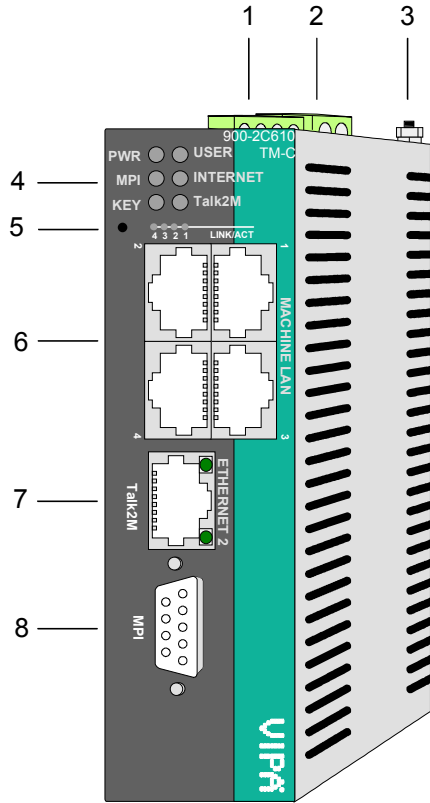

- [1] Connector for digital I/O
- [2] Connector for DC 12...24V power supply
- [3] Earthing screw
- [4] LEDs
- [5] Reset button
- [6] 4xLAN-RJ45 Ethernet interface
- [7] 1xWAN-RJ45 Ethernet interface
- [8] RS485 MPI/PROFIBUS DP interface

Components

LEDs

At the front-side of the Teleservice module there are two rows of LEDs. The following table shows you the usage of the LEDs and the according colors:



Label	Color	Meaning
PWR	green	Power supply is active.
USER	green	blinks: The TM module is ready for communication (ca. 20s after PowerOn).
	red	blinks: IP address not valid (just exist).
	red/green	blinks alternating: The TM module is just waiting for an IP address during boot-up. The LED is also used with the Reset. More about this may be found at "TM - Reset".
MPI	green	blinks: The TM module is communicating with the PLC via MPI.
INTERNET	green	on: Internet access present
KEY	green	on: The digital input of the TM module is "1".
Talk2M	green	on: Talk2M connection active

RJ45 Ethernet-LAN interface

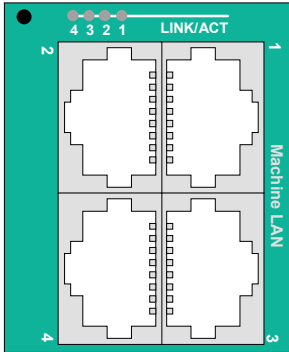

You may connect your TM via Ethernet to the local machine network. Via Ethernet the integrated Web page of the TM module may be accessed for according configurations.

The Ethernet LAN interface is a 4port "autosense" Ethernet switch, which automatically adapts to the transfer rate 10 or 100Mbit/s. By means of this more PLCs within the same network may be connected to the Teleservice module.

The switch has 4 RJ45 jacks.

The assignment of the jacks may be found below at "RJ45 Ethernet WAN interface".

LEDs

Above the switch there are 4 LEDs 4...1. These show the connection of the 4 ports to the Ethernet 4 ... 1.

Color/Activity	Meaning
off	no connection
green	LINK: Connection
blinks green	ACT: Communication

Linking to Ethernet

The LAN interface supports "autosense", here either a crossed or a standard Ethernet cable may be used.

The TM is delivered with the following IP address parameters for the LAN interface:

IP address: 10.0.0.53
Subnet mask: 255.255.255.0

To change the IP address parameters the configuration tool "eBuddy" from VIPA may be used.



Note!

Per default the LAN interface is always activated.

RJ45 Ethernet-WAN interface

By means of the Ethernet WAN interface the TM may be accessed via Internet by the DSL router or an existing local network.

The interface is automatically adapting to the transfer rate 10 or 100Mbit/s.

The jack has the following assignment:

8-pole RJ45 jack:

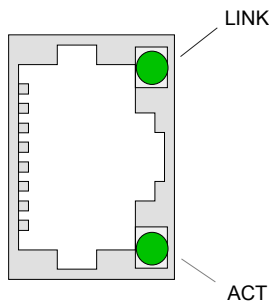

Pin	Assignment
1	Transmit +
2	Transmit -
3	Receive +
4	-
5	-
6	Receive -
7	-
8	-

LEDs (green)

LED	Meaning
LINK	on: Das TM is physically connected to the Ethernet.
ACT	blinks: The TM communicates via Ethernet (Activity)

Connection via Ethernet

The WAN interface does not support "autosense", this means for connection a crossed Ethernet cable or a switch is to be used.

The TM is delivered with the following IP address parameters for the WAN interface:

IP address: **10.0.0.53**
Subnet mask: **255.255.255.0**
Gateway: **0.0.0.0**

To change the IP address parameters the configuration tool "eBuddy" from VIPA may be used.

**Note!**

Per default the WAN interface is always de-activated. For the first connection the LAN interface is to be used.

MPI/PROFIBUS DP interface

The Teleservice module is connected to your PLC CPU via this interface. The interface is designed as RS485 jack and has the following assignment:

9-pole SubD jack:

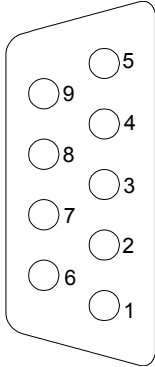

Pin	Assignment
1	n.c.
2	n.c.
3	RxD/TxD (line B)
4	n.c.
5	GND
6	n.c.
7	n.c.
8	RxD/TxD (line A)
9	n.c.

Reset

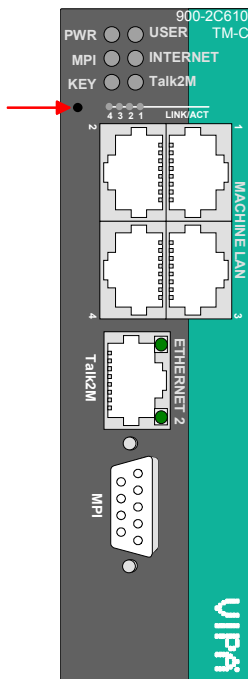

A reset at the Teleservice module may be initiated by the Reset button. The Reset button is allocated below the LEDs behind an opening. Please use for operation a pointed object.

With the reset (*user reset*) extra created Web pages and Tag configurations are erased. Here the communication settings are still remaining.

For a *complete reset* please contact the VIPA support.

More about the deployment of the Reset button may be found at "TM - Reset".



Caution!

An unauthorized *complete reset*, which possibly was not carefully executed, leads automatically to the expiring of the warranty! Then the device must be sent back to VIPA for reprogramming.

Connector power supply

The Teleservice module is to be power supplied by DC 12 ... 24V ±20%. Here the power consumption amounts to 3 ... 6W.

For power supply there is a 2-pin connector at the upper side of the TM module. The connector is a plug with screw contacts. If connected the plugs may be fixed with screws.

The connector has the following assignment:

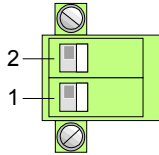

Pin	Name	Meaning
2	12-24V DC	DC 12 ... 24V ±20%
1	GND	Ground power supply

Connector digital I/O

For the digital inputs/outputs there is a connector at the upper side of the Teleservice module. The output is designed as low-side output and may accordingly be configured.

The connector is a plug with screw contacts. If connected the plugs may be fixed with screws.

The I/Os are controlled by *Tags*. An example may be found at the chapter "Deployment" at "Deployment of Tags".

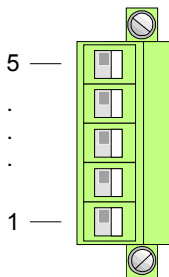

Pin	Name	Meaning
5	DI	Digital input DC 0/24V "0": 0 ... 5V DC "1": 10V ... 30V DC
4	DI_GND	DI ground (isolated)
3	DO_VDC	DO load voltage DC 24V
2	DO	Digital output DC 24V, 0.2A Low-side output
1	DO_GND	DO ground

DI/DO wiring schematic diagram

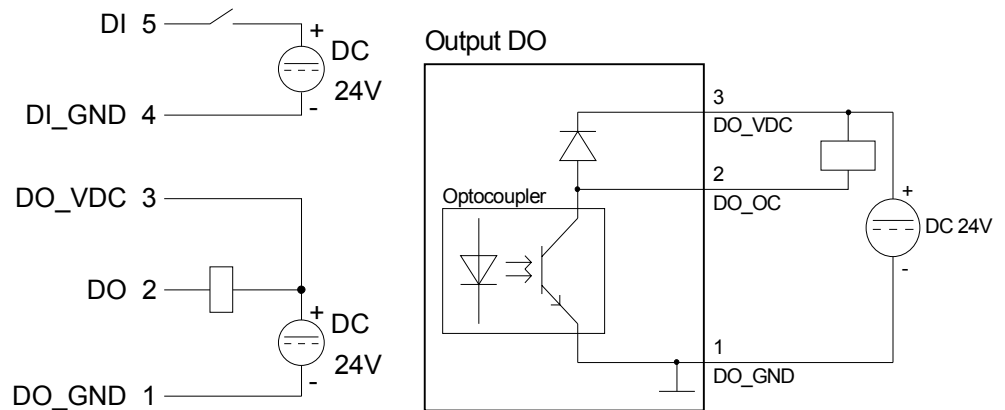

Technical Data

Order no.	900-2C610
Type	TM-C Router
Inputs and outputs	
Inputs	1 DI: 0/24 V DC, isolated
Outputs	1 DO: open drain, max. 200 mA at DC 30 V
Communication	
serial port	MPI/PROFIBUS, isolated, up to 12 MBit/s
LAN	4 x RJ45, 10/100 MBit/s Switch
WAN	1 x RJ45, 10/100 MBit/s
Modem type	-
Router	
Router functions	Talk2M
RAS	-
VPN	
VPN mode	-
Talk2M	✓
Gateway protocols	-
Services	
Server services	FTP HTTP
Client Services	-
Data management	
Custom Website	✓
Project	web interface
Integrated protocols	-
Interrupts	
Alarm message	-
Alarm	-
Housing	
Material	-
Mounting	Profile rail 35 mm
Mechanical data	
Dimensions (WxHxD)	39 x 129 x 108 mm
Weight	410 g
Environmental conditions	
Operating temperature	-20 °C to 70 °C
Storage temperature	-25 °C to 70 °C
Certifications	
UL508 certification	-

Chapter 3 Deployment

Overview

This chapter concerns on the deployment of the Teleservice module (TM) from VIPA with a PLC. With the fast introduction you will get an overview about the possibilities of Teleservice. Another part of this chapter is the configuration of the TM by means of the integrated Web page. The chapter is continued with the possibilities to the PLC connection. Its finished with the description of the communication via VPN.

Content

Topic	Page
Chapter 3 Deployment	3-1
Fast introduction.....	3-2
Assembly.....	3-5
Cabling.....	3-6
TM - Configuration - eBuddy	3-7
TM - Reset	3-13
TM - Web page	3-14
TM - PLC linking.....	3-15
TM - Project integration - PG/PC interface via NetPro	3-18
TM - Project integration - PG/PC interface via eVCOM.....	3-23
VPN connection - Talk2M.....	3-25
VPN connection - PC-Talk2M.....	3-27
VPN connection - TM-Talk2M via DSL/LAN	3-31

Fast introduction

Important note!

The information in this manual should simplify you the deployment of remote controlling VIPA PLCs. More information concerning this may be found in german and english at:

support.ewon.biz
www.ewon-online.de

Power supply

The Teleservice module is to be supplied with DC 12...24V ±20%. The connection is established by a plug. This may be found at the upper side of the module and has the following allocation:

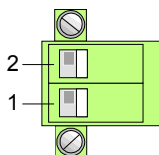

Pin	Name	Meaning
2	12-24V DC	DC 12 ... 24V ±20%
1	GND	Ground power supply

IP address parameters on delivery

For the access to the TM valid IP address parameters are necessary. The IP addresses are assigned by the network administrator and must be coordinated with him.

The TM is delivered with the following IP address parameters:

IP address: 10.0.0.53
Subnet mask: 255.255.255.0

To change the IP address parameters the configuration tool "eBuddy" from VIPA may be used.



Caution!

For every Teleservice module is delivered with the IP address 10.0.0.53 you must not connect more than one new TM at one time.

First commissioning: Connect the new TM with the network, assign TCP/IP address parameters. Now you may connect the next new TM and so on ...

Linking to Ethernet

Connect your PC to the Ethernet-LAN interface (MACHINE LAN) of your Teleservice module via an Ethernet cable.

An active link via Ethernet is shown by the Teleservice module with the green LINK/ACT LED 1 ... 4 upper the Ethernet switch

Access via eBuddy

The software tool "eBuddy" may be found at the download area of www.vipa.com. For installation execute eBuddySetup.exe and follow the instructions.

- Start eBuddy.



- Switch to the list view with "Switch to list mode". Here every TM available in you network is listed.

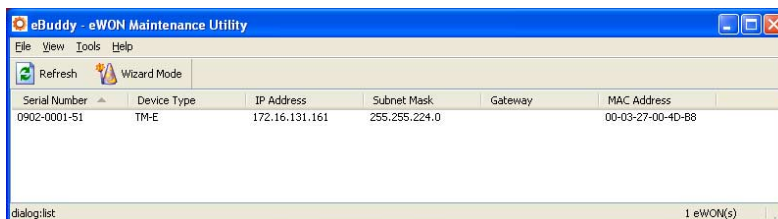

By selecting the corresponding TM at the list, the following functions are available by the context menu (right click):

- Changing respectively entering the IP address parameters
- Loading respectively executing a firmware update
- Backup respectively restoring of an application
- Access to the integrated web page of the Teleservice module

Access to the Web page

Open the Web page of the corresponding TM. After entering *User name* and *Password* the web page of the corresponding TM is opened.

Access parameters

User name: adm
 Password: adm



**Access to the
VIPA PLC**

- Connect your CPU to the Teleservice module via MPI.
- Switch on the power supply of the CPU and switch the CPU to RUN.
- Open the Web page of the corresponding Teleservice module.
- Open with **Settings** > *Gateway* the page for adjusting an I/O server. Set as I/O server "ISOTCP to MPI (Siemens S7-300/400)".
- To access the VIPA PLC enter the following parameters:

<i>MPI/PROFIBUS destination node:</i>	2 (standard)
<i>Protokoll Type:</i>	MPI
<i>Baud rate:</i>	187500
<i>Reply timeout:</i>	3000 (standard)
<i>MPI/PROFIBUS address:</i>	0 (standard)
<i>Highest MPI/PROFIBUS station address:</i>	31 (standard)
- To confirm click [Update config].

Now the CPU may be accessed via the Teleservice module.

Note!

You have the possibility, to see the connected MPI/PROFIBUS stations by clicking of *destination node*. This is not possible until you configure the protocol and the baud rate.

Assembly

General

The modules are installed on a profile rail. You may use the following standard 35mm profile rail:

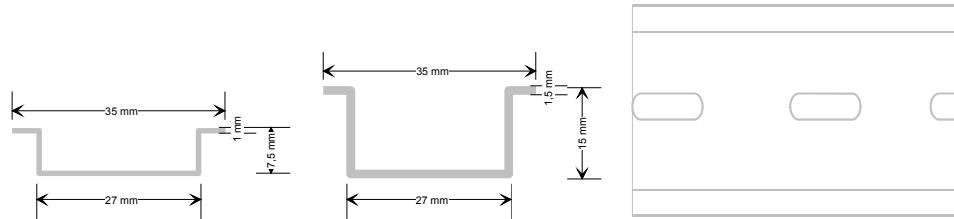

Assembly procedure

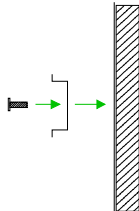

The following sequence represents the assembly procedure as viewed from the side.

- Install the profile rail. Make sure that a clearance of at least 100mm exists above and 70mm below the middle of the profile rail.

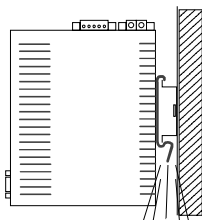
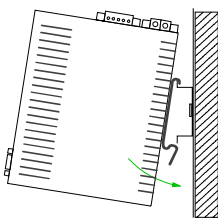
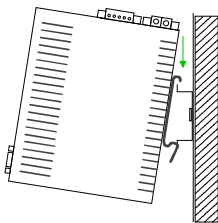

Clack

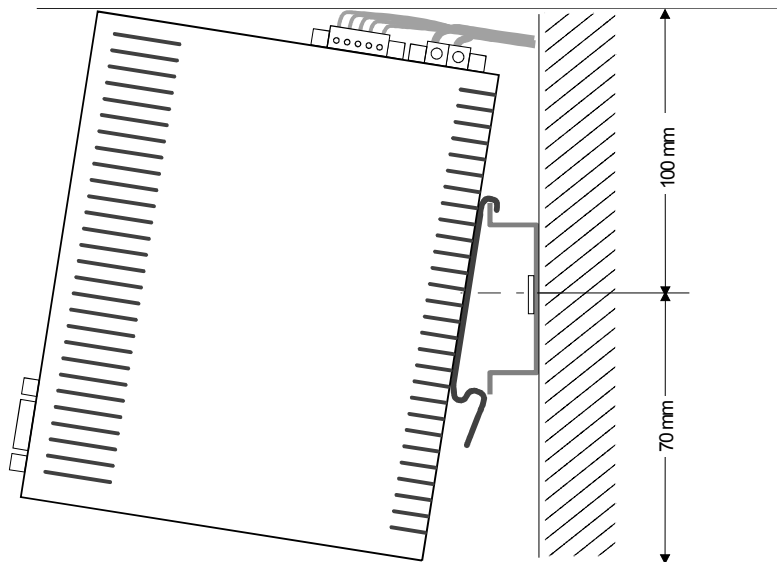

- Insert the module that you are installing into the profile rail at an angle of about 45 degrees from the top and rotate the module into place until it clicks into the profile rail with an audible click.

Cabling

Overview

At the upper side of the Teleservice module there are connectors for power supply and digital inputs/outputs. The output is designed as low-side output and may be configured.

The connectors are plugs with screw contacts. If connected the plugs may be fixed with screws.

The I/Os are controlled by *Tags*. An example may be found at the chapter "Deployment" at "Deployment of Tags".

Power supply

The Teleservice module is to be supplied by DC 12...24V ±20%.

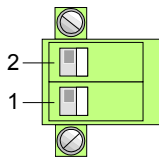

Pin	Name	Meaning
2	12-24V DC	DC 12 ... 24V ±20%
1	GND	Ground power supply

DI/DO connection

The output is designed as low-side output and may be configured.

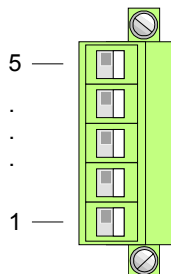

Pin	Name	Meaning
5	DI	Digital input DC 0/24V "0": 0 ... 5V DC "1": 10V ... 30V DC
4	DI_GND	DI ground (isolated)
3	DO_VDC	DO load voltage DC 24V
2	DO	Digital output DC 24V, 0.2A Low-side output
1	DO_GND	DO ground

DI/DO wiring schematic diagram

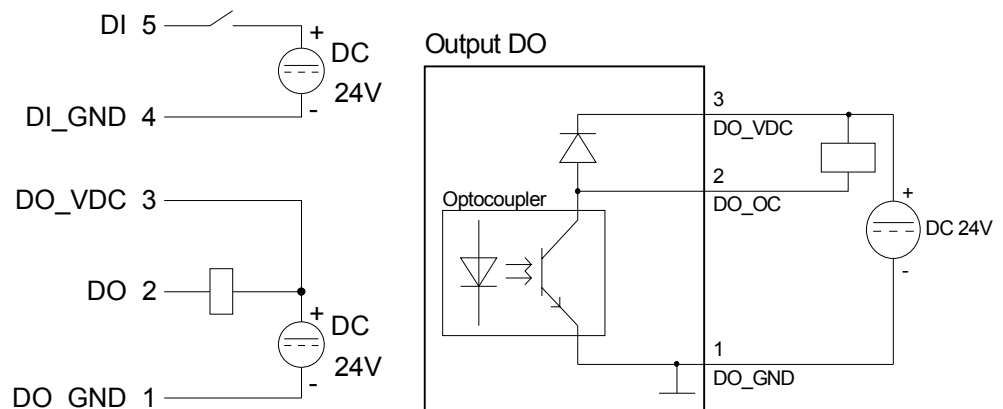

TM - Configuration - eBuddy

Overview

To deploy the Teleservice module, the VIPA software tool "eBuddy" is necessary. With this new IP address parameters may be assigned to the TM; you may load and transfer new firmware, backup/restore applications and access the integrated web page of the TM.

Installation

The software tool "eBuddy" may be found at the download area of www.vipa.com. For installation execute eBuddySetup.exe and follow the instructions.

Wizard mode List mode

Connect the Teleservice module via Ethernet and switch on its power supply. Start eBuddy. This always starts in the last used mode.



Wizard mode

Here the following functions are available:

- Set or modify the IP address parameters
- Load or execute a firmware update
- Backup or restore of an application

List mode

To change to the *List mode* from the *Wizard Mode* click to the link "Switch to list mode". In the *List mode* every TM module available in you network is listed.

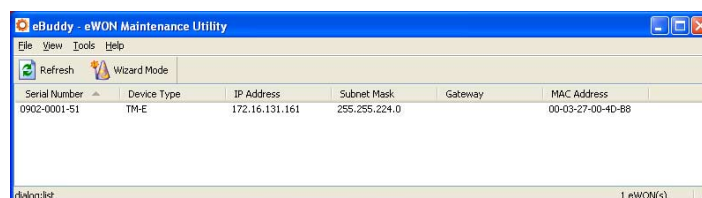

By selecting the corresponding TM in the list, there are the same functions available by context menu (right click), which were listed above.

Additionally the Web page integrated to the Teleservice module may directly be accessed by "Open in browser"

**Basics
IP address
and subnet**

Industrial Ethernet exclusively supports IPv4. At IPv4 the IP address is a 32Bit address that must be unique within the network and consists of 4 numbers that are separated by a dot.

Every IP address is a combination of a **Net-ID** and a **Host-ID** and its structure is as follows: **XXX.XXX.XXX.XXX**

Range: 000.000.000.000 to 255.255.255.255

The network administrator also defines IP addresses.

**Net-ID
Host-ID**

The **Network-ID** identifies a network res. a network controller that administrates the network.

The Host-ID marks the network connections of a participant (host) to this network.

Subnet mask

The Host-ID can be further divided into a **Subnet-ID** and a *new Host-ID* by using a bit for bit AND assignment with the **Subnet mask**.

The area of the original Host-ID that is overwritten by 1 of the Subnet mask becomes the Subnet-ID, the rest is the new Host-ID.

Subnet mask	binary all "1"		binary all "0"
IPv4 address	Net-ID	Host-ID	
Subnet mask and IPv4 address	Net-ID	Subnet-ID	<i>new Host-ID</i>

Subnet

A TCP-based communication via point-to-point, hub or switch connection is only possible between stations with identical Network-ID and Subnet-ID! Different area must be connected with a router.

The subnet mask allows you to sort the resources following your needs. This means e.g. that every department gets an own subnet and thus does not interfere another department.

**Address at first
start-up**

At the first start-up the TM has the following IP address:

IP address: 10.0.0.53
Subnet mask: 255.255.255.0



Attention!

For every Teleservice module is delivered with the IP address 10.0.0.53 you must not connect more than one new Teleservice module at one time. First commissioning: Connect the new TM with the network, assign TCP/IP address parameters. Now you may connect the next new TM and so on ...

Address classes

For IPv4 addresses there are five address formats (class A to class E) that are all of a length of 4byte = 32bit.

Class A	0	Network-ID (1+7bit)	Host-ID (24bit)
Class B	10	Network-ID (2+14bit)	Host-ID (16bit)
Class C	110	Network-ID (3+21bit)	Host-ID (8bit)
Class D	1110	Multicast group	
Class E	11110	Reserved	

The classes A, B and C are used for individual addresses, class D for multicast addresses and class E is reserved for special purposes.

The address formats of the 3 classes A, B, C are only differing in the length of Network-ID and Host-ID.

Private IP networks

To build up private IP-Networks within the Internet, RFC1597/1918 reserves the following address areas:

Network class	Start IP	End IP	Standard subnet mask
A	10. <u>0.0.0</u>	10. <u>255.255.255</u>	255.0.0.0
B	172.16. <u>0.0</u>	172.31. <u>255.255</u>	255.255.0.0
C	192.168.0. <u>0</u>	192.168.255. <u>255</u>	255.255.255.0

(The Host-ID is underlined.)

These addresses can be used as net-ID by several organizations without causing conflicts, for these IP addresses are neither assigned in the Internet nor are routed in the Internet.

Reserved Host-IDs

Some Host-IDs are reserved for special purposes.

Host-ID = 0	Identifier of this network, reserved!
Host-ID = maximum (binary complete 1)	Broadcast address of this network



Note!

Never choose an IP address with Host-ID=0 or Host-ID=maximum!
 (e.g. for class B with subnet mask = 255.255.0.0, the "172.16.0.0" is reserved and the "172.16.255.255" is occupied as local broadcast address for this network.)

Changing the IP address

For the access to the Teleservice module valid IP address parameters are necessary. The IP addresses are assigned by the network administrator.

Per default the Teleservice module is delivered with the IP address 10.0.0.53. You may switch to the IP address parameter wizard with "Set IP address".

By clicking to [Browse...] each TM of the network is listed.

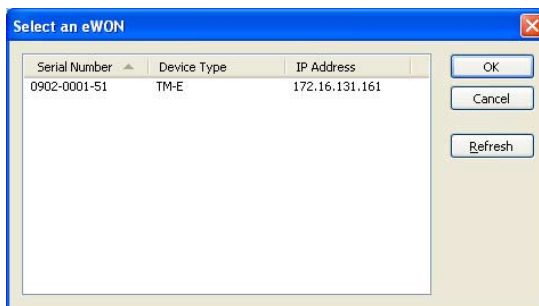

- Choose the TM, which corresponds to the serial number. Confirm your input and click to [Continue >].
- The dialog window to enter IP address data is opened.
- Enter the new IP address parameters. By clicking to [Continue >] the new IP address parameters are transferred to the TM.
→ The TM module is started new. After a certain waiting period and during successful transmissions this is reported.
- [Finish >] closes the dialog.

Symbolic name instead of IP address

With each new dial-in of the Teleservice module, this is assigned automatically with a new IP address. This is called dynamic address allocation.

Usually the TM sends an eMail containing the current valid IP address. By this IP address the TM may be accessed.

With the service of a DNS service provider like e.g. www.no-ip.com there is the possibility to directly access the TM by a name instead by the IP address.

Here usually a free user account is to be established.

The corresponding DNS service provider may be selected on the Web page of the TM at "Networking config" with the page "Publish IP address". Here the user data may be entered.

During communication the dynamic IP address is submitted to the service provider and there transformed to the symbolic name.

Update firmware

A firmware update happens in 2 steps:

- Update eBuddy
- Update firmware

Update eBuddy

With "Update eBuddy" the firmware files may directly be stored at you PC. This is necessary to update the firmware of you TM.

As source the Internet or a local directory may be selected. With [Continue >] the available firmware language versions are listed. Select the corresponding version and download it with [Continue >] to your PC.

Update firmware

With "Update firmware" a dialog window is opened to request the login data. By selecting the corresponding TM and by entering the login data, the firmware versions at your PC and at the Teleservice module are listed.

Choose the concerning firmware version at your PC. The update procedure is started by [Continue >].

**Attention!**

When installing a new firmware you have to be extremely careful. Under certain circumstances you may destroy the TM, for example if the voltage supply is interrupted during transfer or if the firmware file is defective. In this case, please call the VIPA-Hotline!

The proceeding of the update is shown as a proceeding bar. Wait here until the bar is at 100%.

A successful update is reported by a status report.

Backup / restore application

With this function the configuration of a Teleservice module may be stored and uploaded to the TM module.

Each modification on the configuration of the TM should be stored.



Backup

Open the dialog window with clicking to "Backup/restore application". Select "Backup". Even if you want to forward the backup to the VIPA support the files relevant to the support should also be saved. Here activate the option "Include support files". Click to [Continue >].

Select the corresponding Teleservice module, enter your login data and click to [Continue >]. Navigate to the concerning directory and enter a file name.

With [Continue >] the backup is stored with the file name in the concerning directory.

The proceeding of the write procedure is shown as a proceeding bar. Wait here until the bar is at 100%.

As soon as the backup is finished, you get a feedback.

Restore

Open the dialog window with clicking to "Backup/restore application". Select "Restore" and click to [Continue >].

Select the corresponding TM, enter your login data and click to [Continue >]. Navigate to the concerning directory and enter a file name of the backup.

With [Continue >] the data are transferred to the TM.

The proceeding of the write procedure is shown as a proceeding bar. Wait here until the bar is at 100%.

As soon as the restore is finished, you get a feedback.

TM - Reset

Overview

At the front-side of the Teleservice module there is a Reset button. This may be located below the LEDs and may be operated by a pointed object.

With the Reset (*user reset*) extra created Web pages and Tag configurations are erased. Here the communication settings are still remaining.

For a *complete reset* please contact the VIPA support.



Caution!

An unauthorized *complete reset*, which possibly was not carefully executed, leads automatically to the expiring of the warranty!

Then the device must be sent back to VIPA for reprogramming.

User-Reset

There is the following proceeding for the *user reset*:

- Switch-off the Teleservice module.
- Press the Reset button.
- Switch-on the Teleservice module and leave the reset button pressed as long as the "USER"-LED is blinking red.
- Release the Reset button now.

Now the Teleservice module executes a restart. Wait until the "USER"-LED blinks green.

TM - Web page

Access to the Web page

- Start the VIPA configuration tool "eBuddy".
- Switch to the list view with "Switch to list mode". Here every TM available in your network is listed.

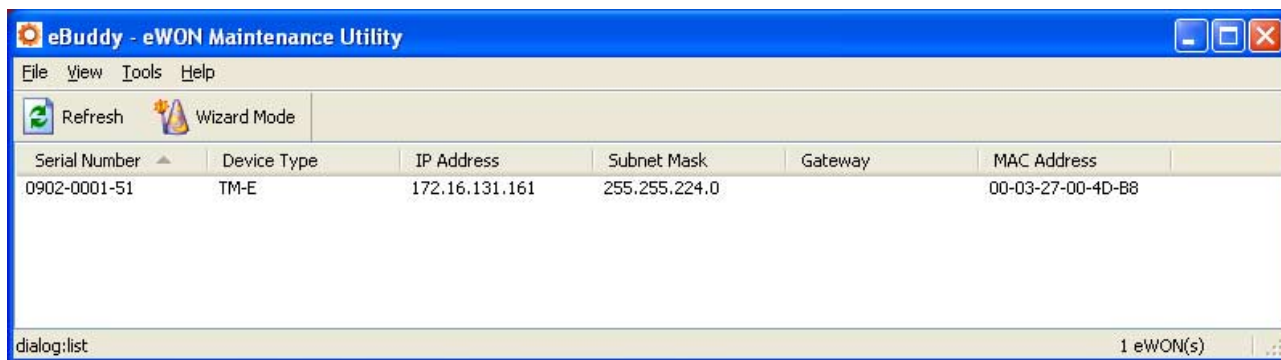

- Click to the concerning TM and select in the context menu "Open in browser". Your Web browser is opened with the request of *User name* and *Password*.
Per default the TM is delivered with the following user data:

User name: adm
Password: adm

After entering *User name* and *Password* the web page of the corresponding Teleservice module is opened.

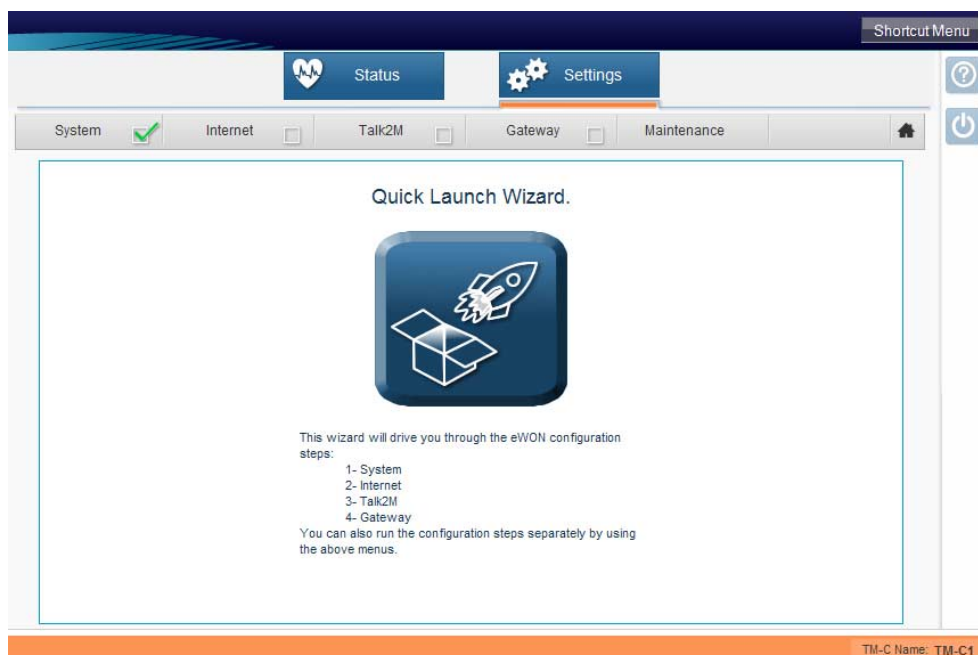

TM - PLC linking

Preconditions

For the further approach there is condition your Teleservice module has valid IP address parameters and the Web page of the TM may be accessed.

Connect VIPA PLC via MPI

To get access to the VIPA PLC, the VIPA CPU is to be connected to the MPI jack of the Teleservice module via a suited MPI cable.

If there is an Ethernet CP within your PLC, for TM access you may connect it to Ethernet instead to MPI.

Switch-on the power supply of the CPU and switch the CPU to RUN.

Configure VIPA PLC in TM

Open the Web page of your TM by entering the LAN IP address of your Teleservice module into the address bar of your Internet browser. The default *username* and *password* are adm.

- After entering of *User name* and *Password* the Web page of the Teleservice module is opened.

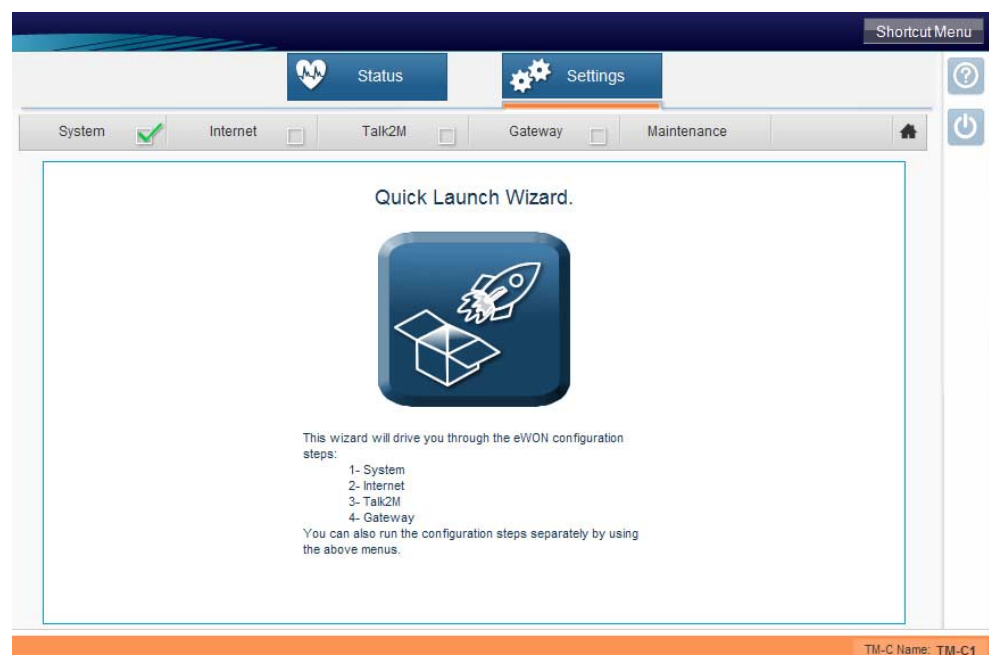

- To reach your automation components (e.g. PLCs, Panels, IPCs, Web cams) via Ethernet, you do not have to configure your TM. The Ethernet Gateway and the Plug'n Route Feature are activated by default.
- To connect your automation components (e.g. PLCs) via MPI/PROFIBUS/PPI, you have to configure the gateway of your TM.

I/O server configuration

- Select the suitable IO protocol. In this case ISOTCP to MPI (Siemens S7-300/400) and click [Next>>].

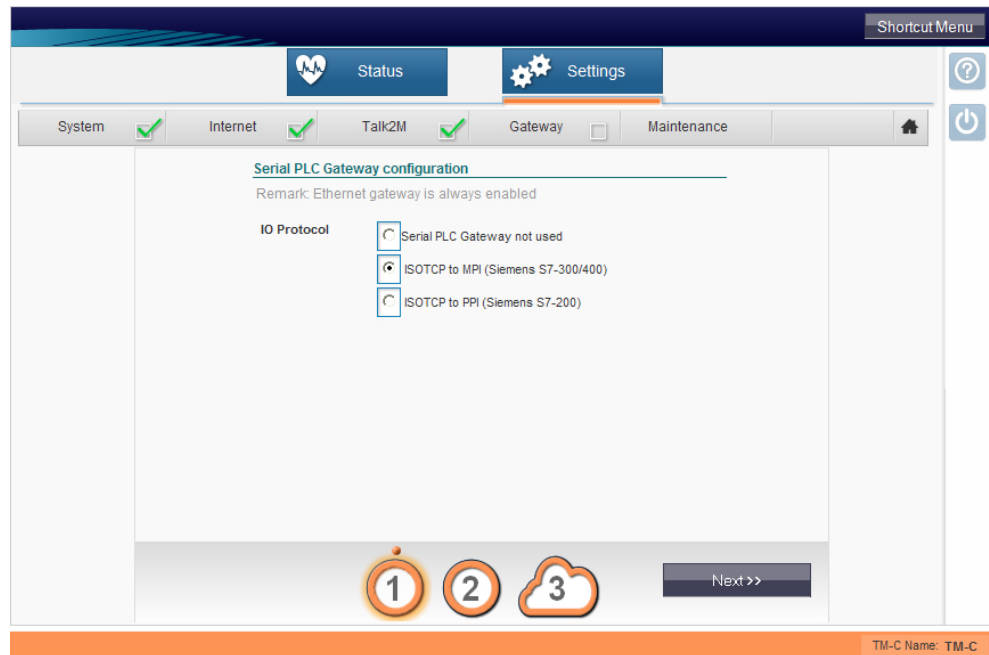

- Enter the communication settings of your PLC and select the used protocol. After that click [Save>>] to finish and to activate the gateway configuration.

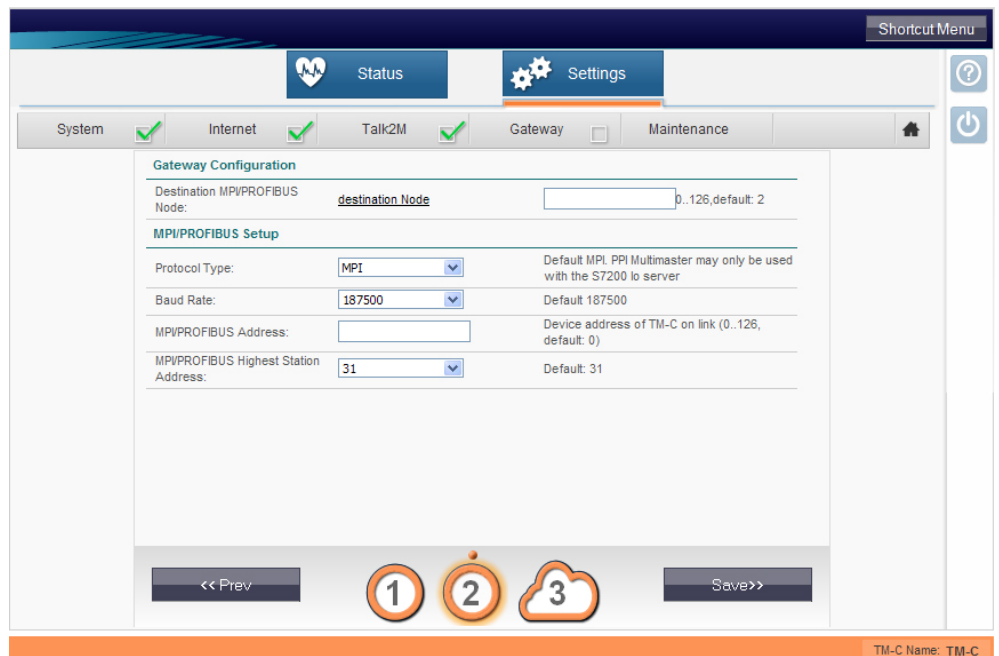

Note!

You have the possibility, to see the connected MPI/PROFIBUS stations by clicking of *destination node*. This is not possible until you configure the protocol and the baud rate.

- After clicking [Save>>] you will receive the following message, that confirms your configuration was successful.

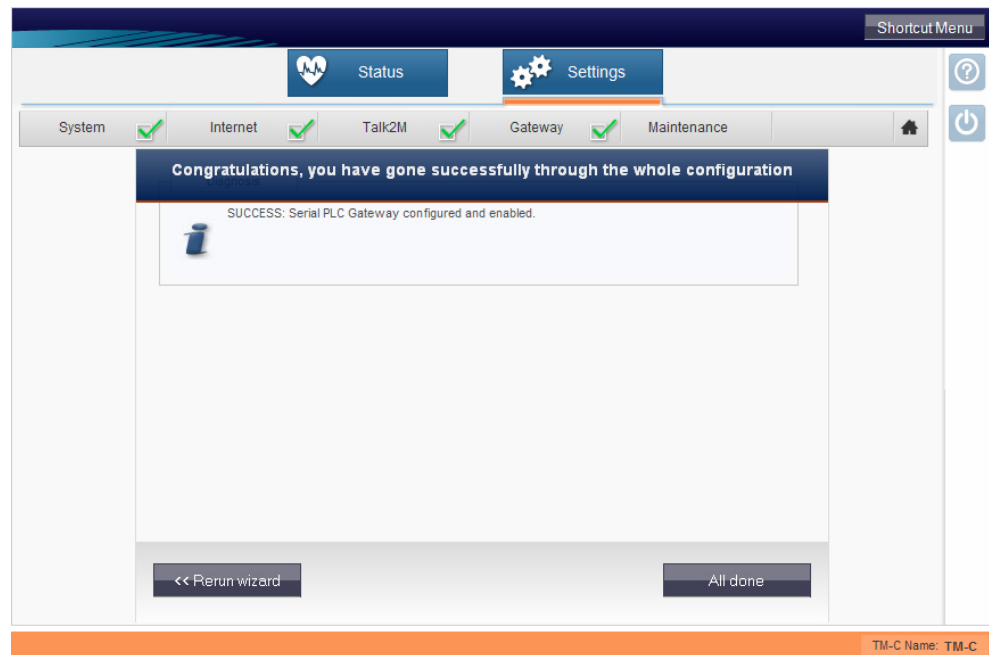

TM - Project integration - PG/PC interface via NetPro

- Precondition** For the further approach it is precondition that you have access to the Web page of the Teleservice module and your CPU is connected to the Teleservice module via MPI and is accordingly configured (see "TM - PLC linking").
- For the project engineering, a thorough knowledge of the Siemens SIMATIC manager the hardware configurator and NetPro is required.
- IP address and subnet mask of your PC are known.
- Teleservice** With the teleservice the Teleservice module works as gateway. As gateway via the served communication connections you have access to the VIPA PLC, which is connected via MPI to the TM.
- So that the TM can work as gateway, you have to integrate this to your hardware configuration.
- Load TM-H.cfg station file** For the deployment of the Teleservice module in the Siemens SIMATIC manager, the installation of the station file TM-H.cfg is necessary.
- This file may be found in the download area at www.vipa.com.
- Download this file to your PC. Later this file is to be imported to the PG/PC interface.
- De-activate the automatic IP address assignment** Since in the Teleservice module predefined IP address data for the PPP server are used, in your project you have to de-activate the automatic address assignment.
- Start the Siemens SIMATIC manager with your project. Your project should contain your CPU, which is connected via MPI to the MPI bus.
 - Open via **Options** > Set *PG/PC interface* the properties dialog.
 - Select the interface parameter assignment "TCP/IP(Auto)...", which corresponds to your network card and click to [Properties].
 - Select the Register "IE-PG Access" and activate the parameter "Do not assign IP address automatically".
 - Confirm your setting with [OK].

Integrate the TM module to the Siemens SIMATIC manager

The integration of the Teleservice module to your project happens as PG/PC interface. After the configuration this may be defined as access path for the PLC functions.

The configuration happens with the following approach:

- Start the software NetPro, by clicking to .

For example you see the following structure:

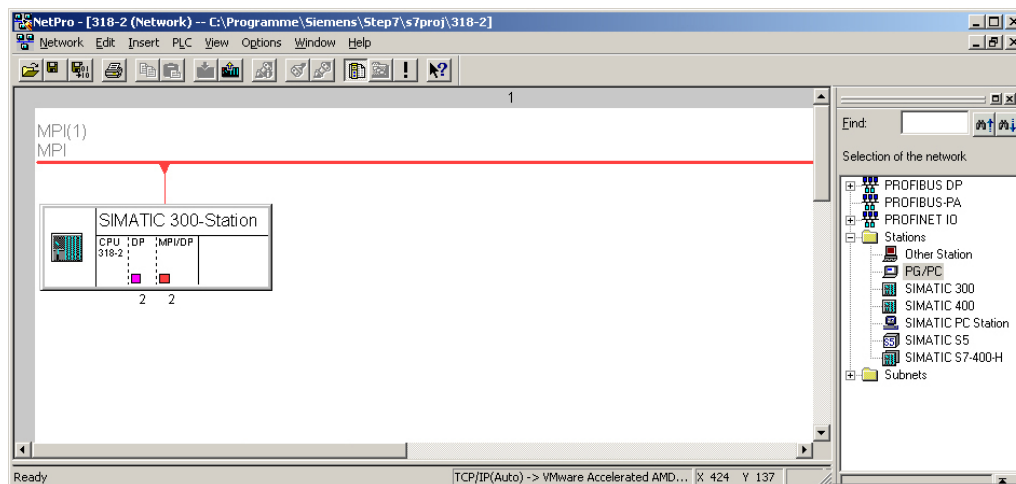

Add PG/PC station

- Add the station "PG/PC" from *Network*, by double-clicking to the station "PG/PC".

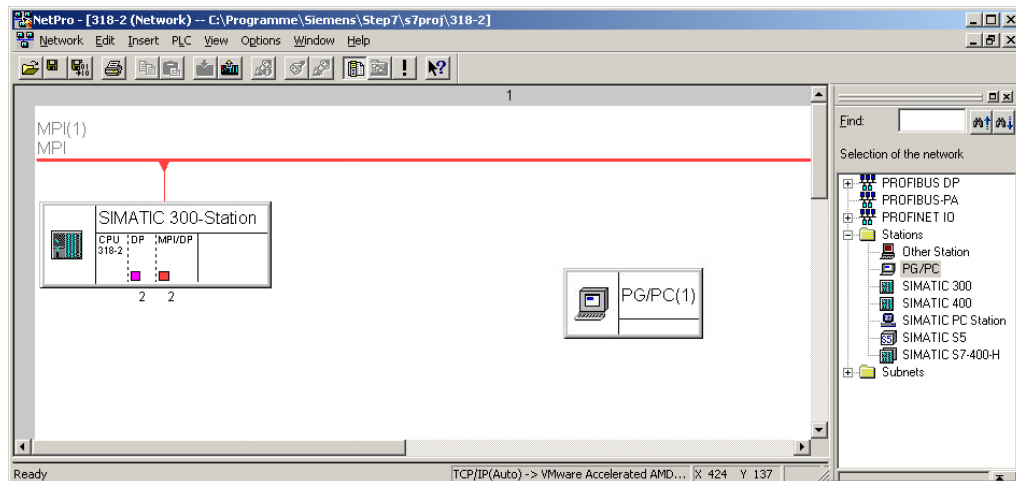

Properties
PG/PC station

- Open the properties of the PG/PC station.
- Access the register "Interfaces" and click to [New...].
- Select the type "Industrial Ethernet" and click to [OK].
- De-activate "Set MAC address..."
- Enter at "IP address" and "Subnet mask" the IP address parameters of you PC determined before.

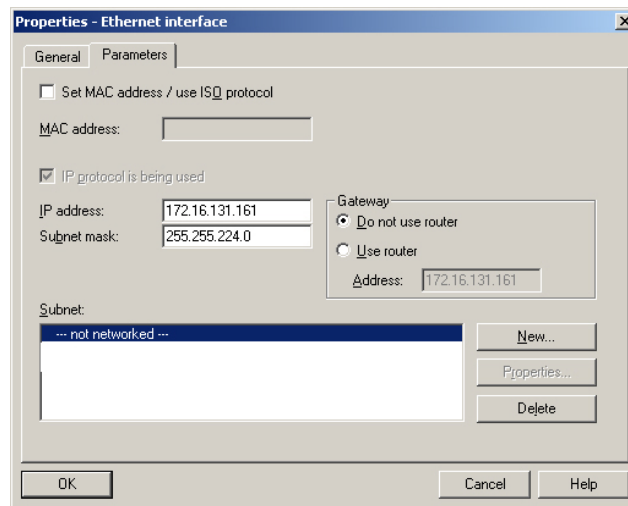

- To establish a new subnet click at [New...].
- Confirm the properties with [OK].
- Select if not happened the new established subnet and click at [OK]. Now you are back in the properties dialog.
- Call the register "Assignment".
- Highlight at "Configured Interfaces" your Ethernet interface and select at "Interface parameter assignments in the PG/PC" the parameter, which starts with "TCP/IP(Auto) ->..." and corresponds to your network card.
- Click at [Assign].

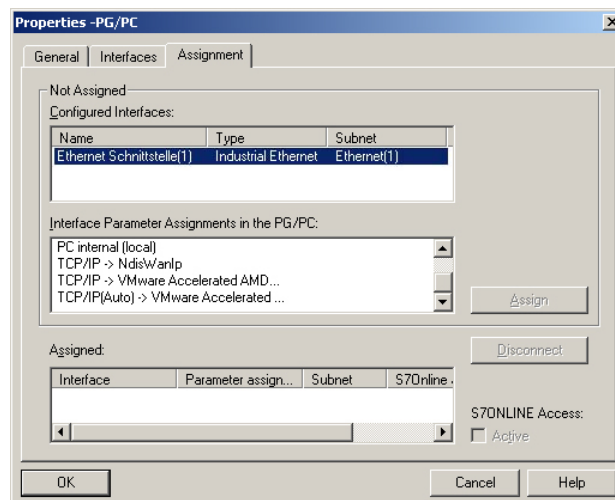

- Ignore the warn messages and close the "properties" dialog with [OK].

Now your graphical net view should show the following structure:

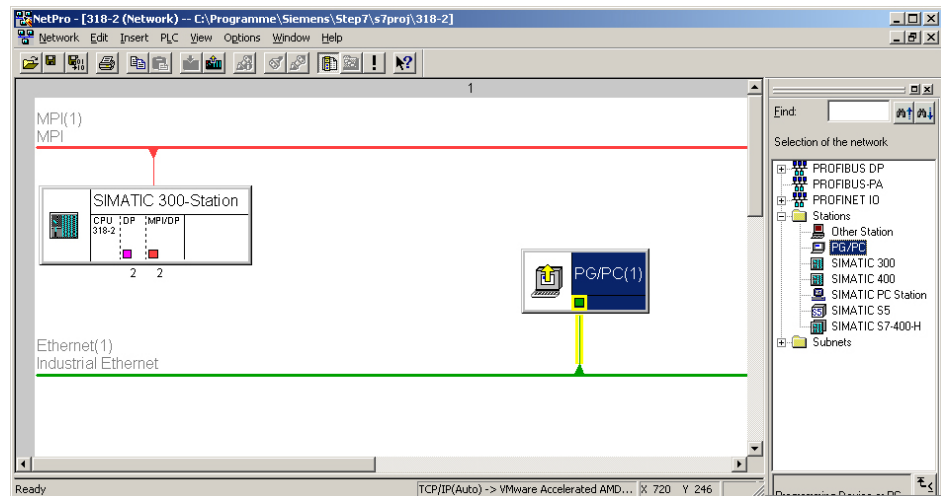

Import the TM module via station file

To import the Teleservice module to your project the first downloaded station file is necessary.

- Start in NetPro the import via **Edit > Import**.
- Activate the parameter "Export file of a station".
- Enter path and name of the station file TM-H.cfg and click to [OK]. Possibly appearing warnings may be ignored by [Close].

Now your graphical net view should show the following structure:

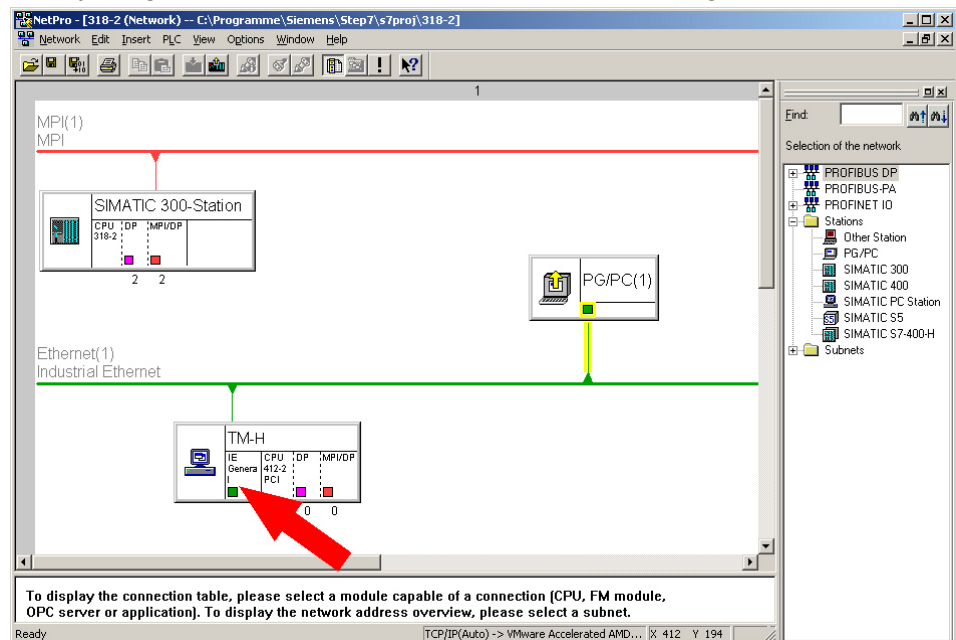

- Open the properties dialog of the communication component "IE General" of the station "TM".
- Click in the area "Interface" at [Properties...]. A dialog window for IP address data settings is opened.

Define access via IP address

Depending on the access modes to your Teleservice module, there are the following possibilities to preset IP address parameters:

Access via Ethernet

Enter here IP address and subnet mask of your TM. The IP address parameters must correspond to the IP address parameters, which were preset with the software tool "eBuddy".

Access via VPN connection

With a Teleservice module, which communicates via Talk2M, the IP address may be found in the communication software "eCatcher".

As soon as a connection to the Teleservice module is established, the IP address is shown in the "eCatcher".

Set the MPI address

Open the properties dialog of the communication component "MPI/DP" of "TM-H". Enter the MPI address. This must correspond to the MPI address preset by the software tool "eBuddy".

NetPro should now show the following structure:

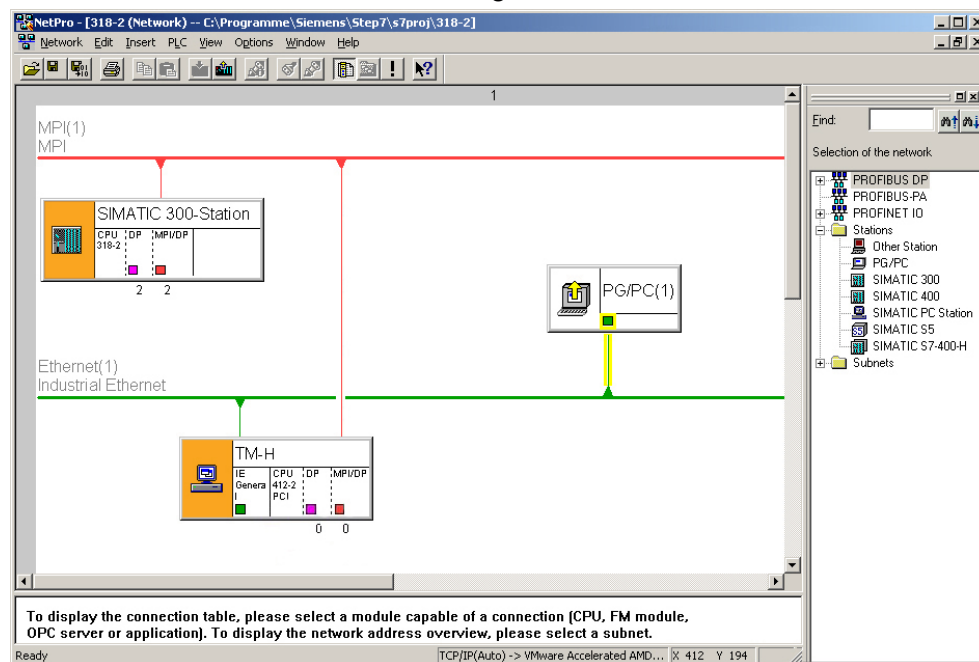

Save and compile project

Save and compile your project with **Network** > *Save and compile* respectively with .

Now your CPU may be accessed via this connection from the Siemens SIMATIC manager.

TM - Project integration - PG/PC interface via eVCOM

Overview

As another version here the project integration is to be shown by means of a virtual MPI interface. To do this on the PC side the driver "eVCOM" from VIPA is to be installed. Contrary to "Project integration via NetPro" no adjustment is necessary on the PLC side. This version is easy to use but slower than "Project integration via NetPro".

With this functionality HMI devices may be accessed, which were configured via MPI.

With the teleservice the Teleservice module works as gateway. As gateway via the served communication connections you have access to the PLC, which is connected via MPI to the TM.

Precondition

For the further approach it is precondition that you have access to the Web page of the Teleservice module and your CPU respectively your HMI device is connected to the Teleservice module via MPI and is accordingly configured (see "TM - PLC linking").

Installation

The driver file "eVCOM" may be found in the download area www.vipa.com. For installation start eVCOMSetup.exe and follow the instructions.

Establish virtual interface

- Start eVCOM.
- In the Dialog window click at [Add Port].
- Select a free COM port of your PC and choose "MPI ISO TCP" for MPI communication.

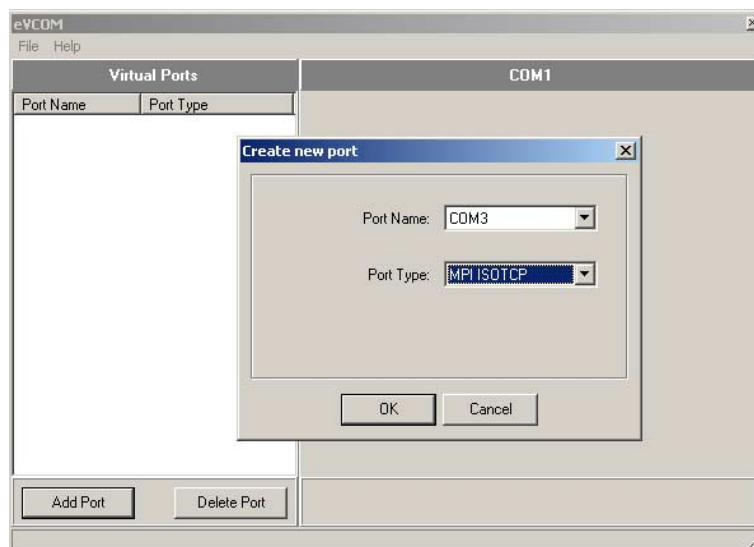

- Confirm your settings with [OK].
- Enter at *Gateway address* a valid IP address (see below).
- Do not change the *Gateway port* "102".
- Confirm you settings and click at [Enable Port]. The virtual MPI interface is now activated. This is shown by the symbol  in the list.

Define access via IP address

Depending on the access mode to your Teleservice module, there are the following possibilities to preset the IP address:

Access via Ethernet

The IP address must be the same as the IP address, which was preset by the software tool "eBuddy".

Access via VPN connection

With a Teleservice module, which communicates via Talk2M, the IP address may be found in the communication software "eCatcher".

As soon as a connection to the Teleservice module is established, the IP address is shown in the "eCatcher".

Settings in the Siemens SIMATIC Manager

- Load your project in the SIMATIC manager from Siemens.
- Choose in the menu **Options** > *Set PG/PC interface*.
- Select in the according list the "PC Adapter (MPI)"; if appropriate you have to add it first, the click at [Properties].
- Switch to the register *MPI*.
- Set the transfer parameters of your MPI net and type in an unused address.
- Switch to the register *Local connection*.
- Select the COM port, which you have configured at eVCOM and set the transfer rate to 38400baud. Confirm you settings with [OK]. Now your CPU may be accessed with the TM via MPI by means of the PLC functions.

VPN connection - Talk2M

VPN

VPN (Virtual Private Network) is an interface in a network, which serves to bind devices from their original net to another attainable net. The networks do not have to be compatible. A VPN connection is secured by coding mechanisms. The VPN technology serves for a safe and cost-effective connection of branches respectively regional offices. Internal data may be surely transferred via VPN.

Functionality

VPN works with the client server principle, this means there must be always at least a client and a server. The Teleservice module can be both client and server.

For the communication of the assigned net with its communication partner the original network packages are packed into a VPN protocol and transferred to the communication partner. This is called *tunnel*.

A tunnel software on the client and server serves for embedding third-party data to the tunnel and extracting the data at the other side.

In relation to other kinds of tunnel of a TCP/IP net the VPN tunnel is characterized by the fact that it passes every network packages independently of higher protocols (HTTP, FTP etc.). On this way it is possible to transfer the data traffic of two net components practically unrestricted through an other network, which is not safe like the Internet .

The Teleservice module uses OpenVPN. OpenVPN tunnels the data safely through one port (standard port 1194). The data are coded SSL based 128bit. For the transfer UDP is used by the OpenVPN protocol.

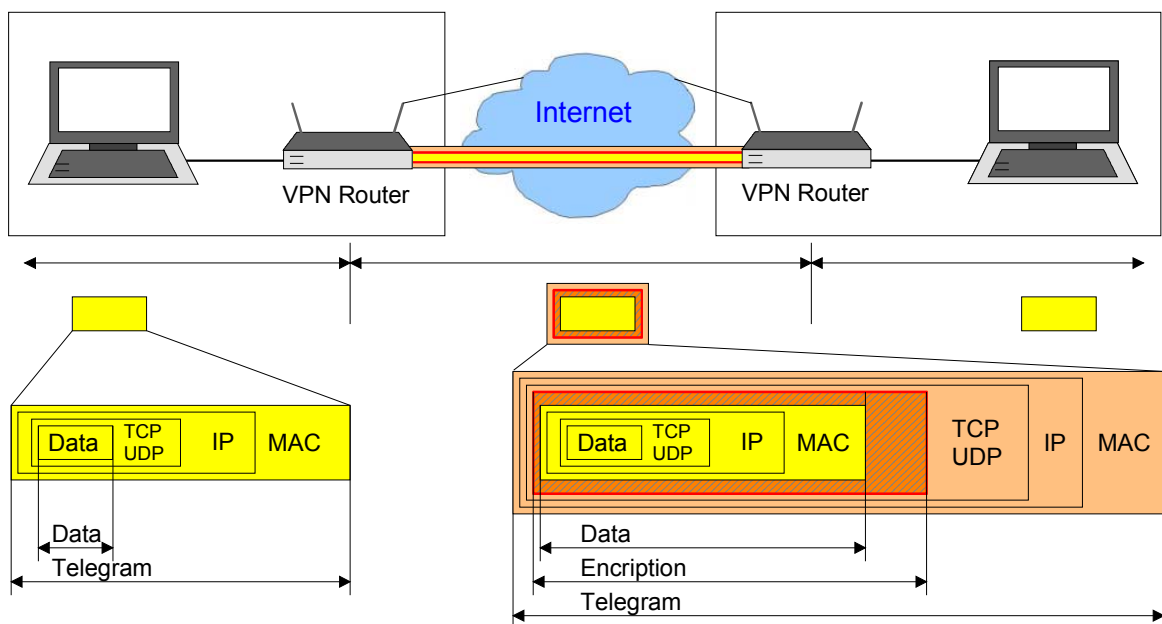

Talk2M

Talk2M (**Talk to Machine**) is a service, by means of which you may reach your plant word-wide via cellular radio or DSL/LAN. Talk2M communicates fully secured over VPN. Since Talk2M only uses outgoing connections, problematic points like firewalls, missing open ports and dynamic IP addresses may be handled

The Talk2M server is permanently connected to the Internet. To establish a VPN connection between your PC and your plant, your PC and your Teleservice module must be registered at the VPN server.

If both participants are registered at the Talk2M server, a VPN connection is established between your PC and your plant.

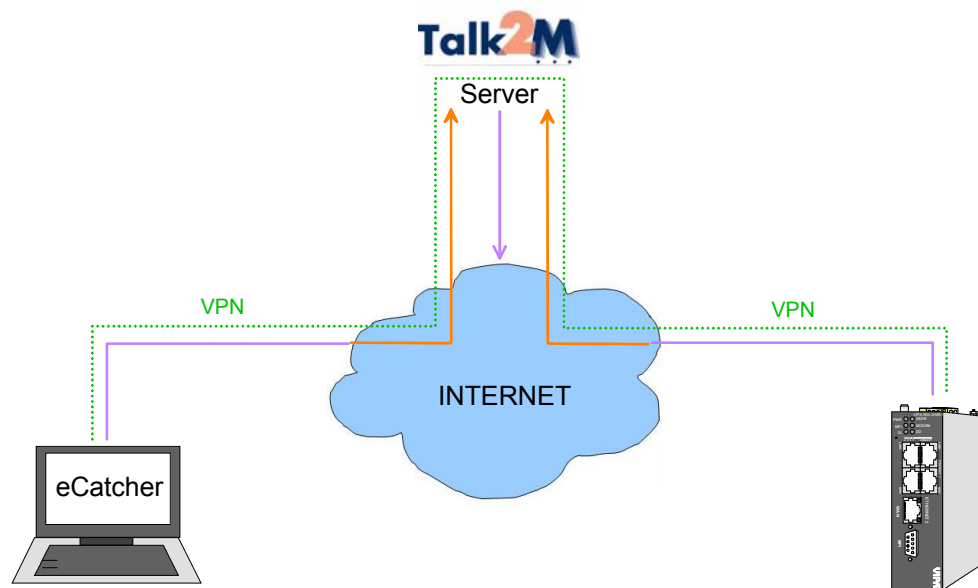

Fast introduction

For the access via VPN the following steps are necessary:

- Install the software "eCatcher" at your PC (www.talk2m.com).
- Create a Talk2M account via eCatcher. Check if necessary the network settings by means of the *Testbox* of Talk2M.
- Add your Teleservice module to the account.
- Configure the Teleservice module for the Talk2M connection.
- Connect the Teleservice module to the Talk2M server.

VPN connection - PC-Talk2M

Approach

For the access with your PC to Talk2M following steps are necessary:

- Install the software "eCatcher" at your PC.
- Create a Talk2M account via eCatcher.
- Add your Teleservice module to the account.
- Configure the Teleservice module for the Talk2M connection.
- Connect the Teleservice module to the Talk2M server.

Installation eCatcher

- Open www.talk2m.com
- Download the free software "eCatcher".
- For installation start eCatcherSetup.exe and follow the instructions

After installation the eCatcher starts automatically.

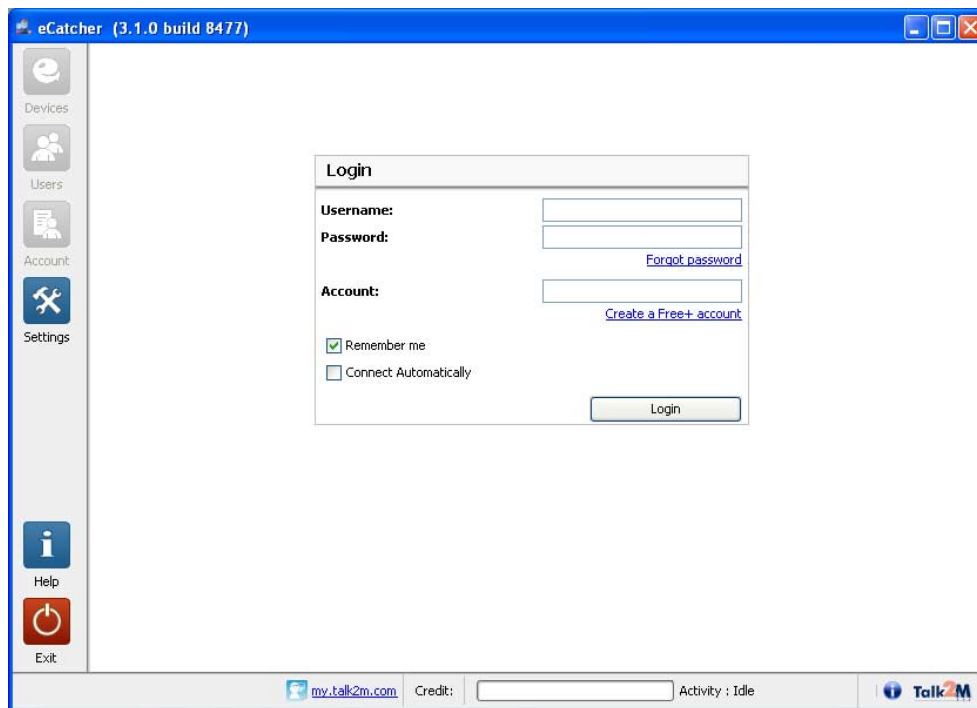

Creating a Talk2M account

- Create an account by clicking to [Create a Free+ account]. With the first creation of an account you get a 15€ credit.
- Enter a Talk2M-Account name, a user name, a password and your email address.
- Confirm your settings with [Next].

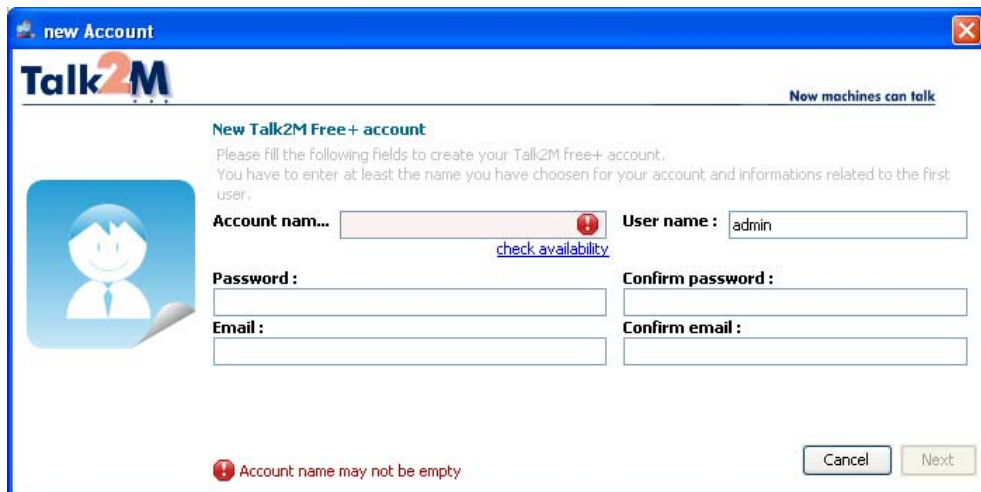

- At the following dialog window enter your company data. The VAT number is necessary to recharge the credit of your Talk2M-Account. You may add it later.



- By clicking [Finish] the account is created and your system is automatically connected to the Talk2M server.

Network settings for the use of Talk2M If there is no connection to Talk2M possible, for communication via Talk2M the following network settings must be checked. Please ask here if necessary your system administrator.

Internet connection An Internet connection via standard gateway in your network or via DSL router with integrated modem should be exist.

Connection parameters If there is a proxy server, you have to know the connection parameters to access the proxy server:

- Proxy server name or IP address (e.g. Proxy.company.com:8080)
- Proxy user name
- Proxy password

Addresses The following addresses must be reachable:

- ping.talk2m.com 87.98.150.3
- ecatcher.talk2m.com 87.98.150.4
- ewon.talk2m.com 87.98.150.6

Ports To create an outgoing VPN channel the following ports are necessary:

- Port 80 (Web access)
- Port 1194 (UDP) or Port 443 (HTTPS)

Automatic check of the network settings To check the network settings in the installation directory there may be found the program TestBox.exe. Start this program.

After starting the program a test is automatically executed

If the test reports an error, eCatcher is not able to get connection to Talk2M. Please check your settings again.

If there is no error, the communication via Talk2M is possible.



Configure Talk2M and connect to TM

If the connection to the Talk2M server was successfully established, the configuration dialog is shown.

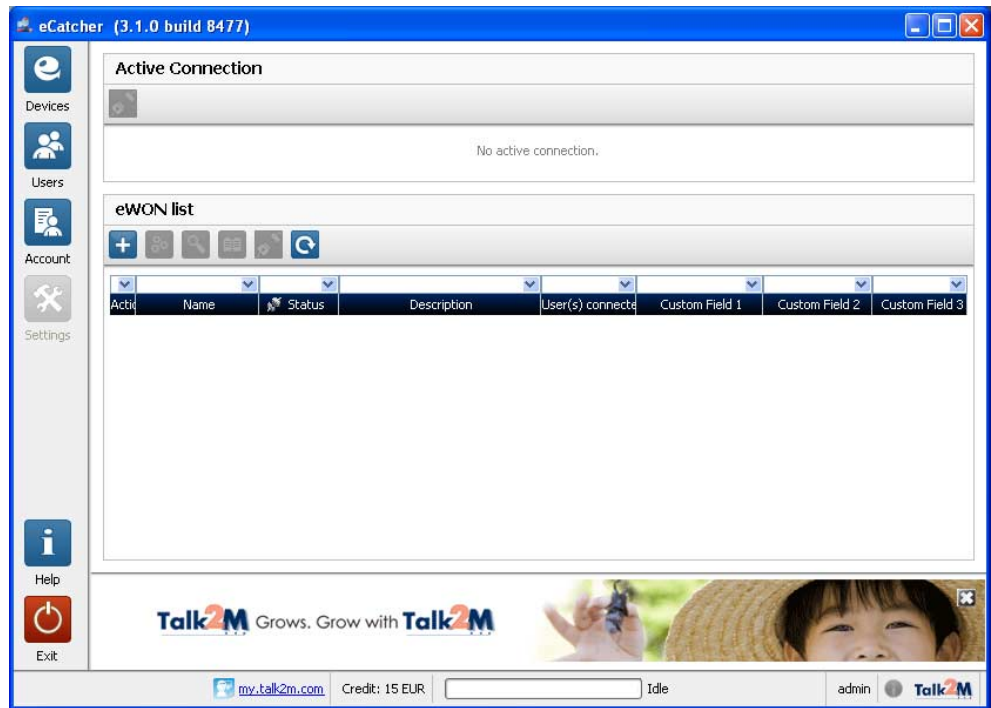

VPN connection - TM-Talk2M via DSL/LAN

Principle

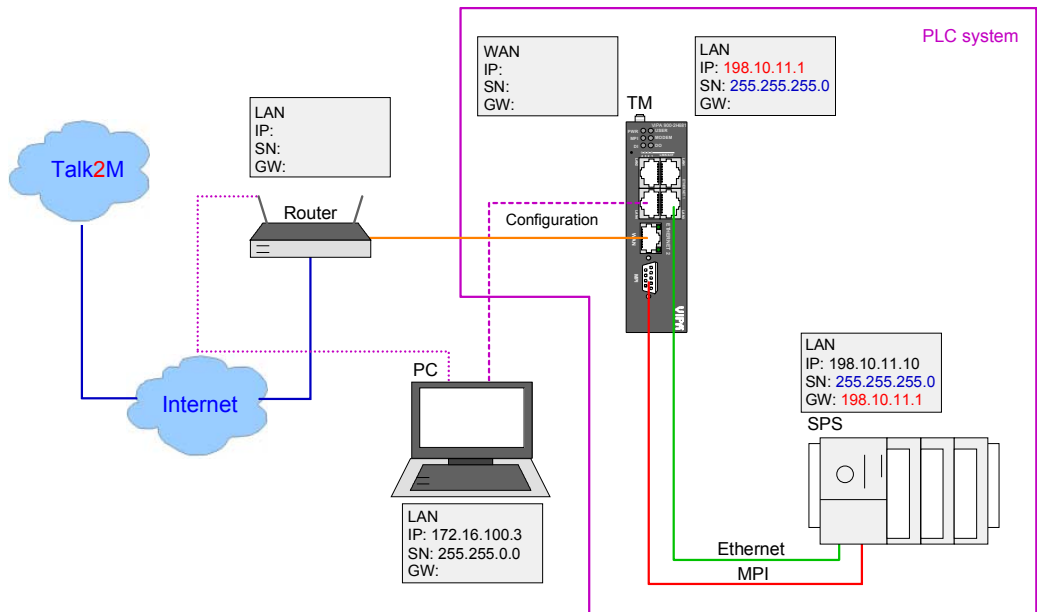

Connect TM to Talk2M via DSL/LAN

Start the program eCatcher. If the connection to the Talk2M server was successfully established, the configuration dialog is shown. The configuration dialog is divided into 2 parts.

In the upper part the active connections are shown. In the lower part the Teleservice modules (TM) are listed which are connected to the server. With the first-startup still no modules are listed.

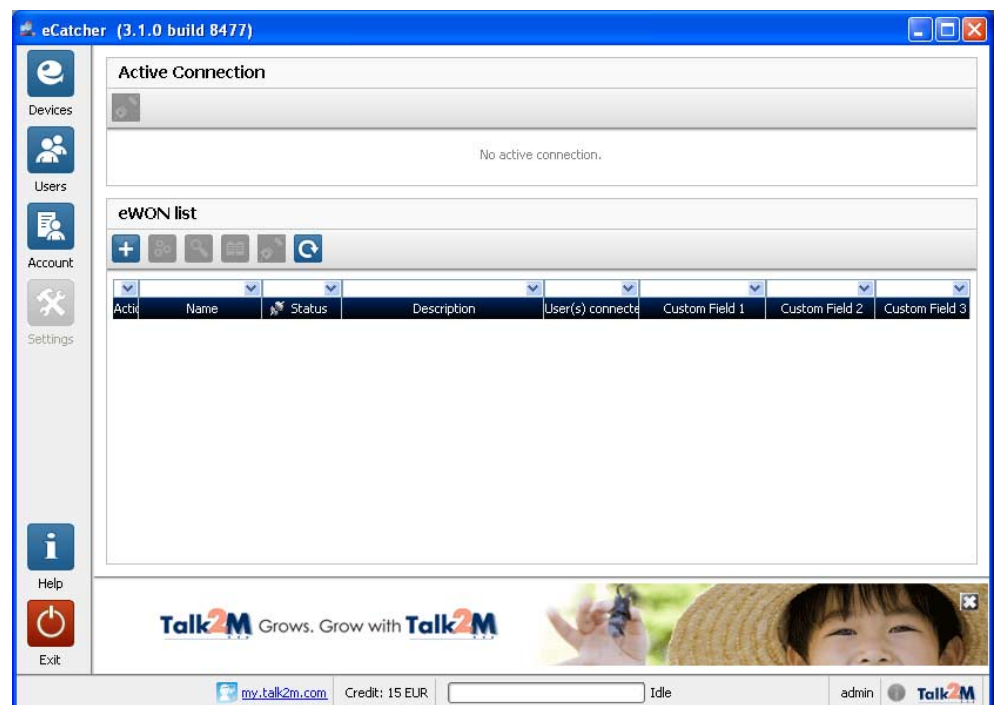

Proceeding registration of a TM at Talk2M

- Click  to add a new Teleservice module. The following dialog window opens:

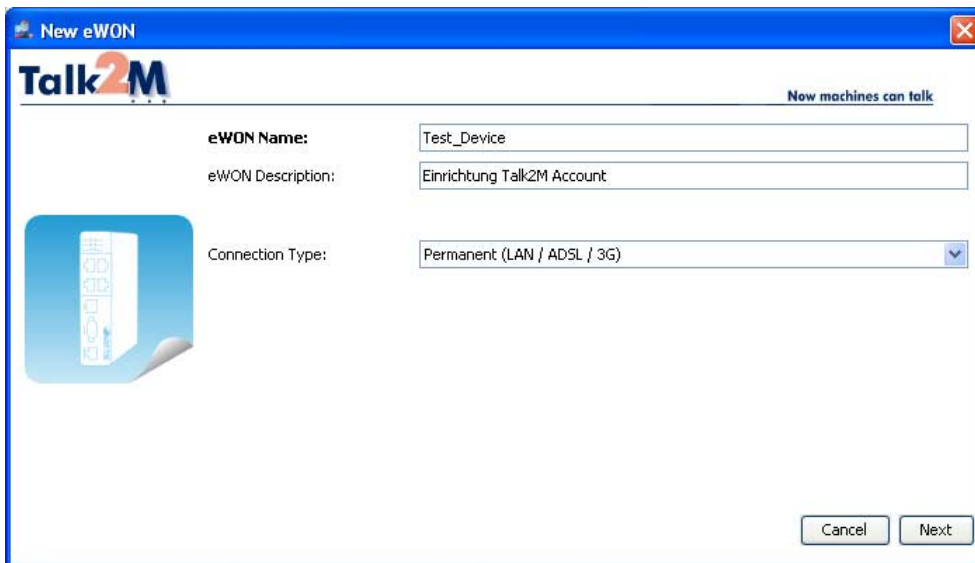

- In the *Name* field enter a suited name for your TM. You may leave the *Description* field empty.
- Select at *Connection type* "LAN/ADSL".
- Confirm with [Next].

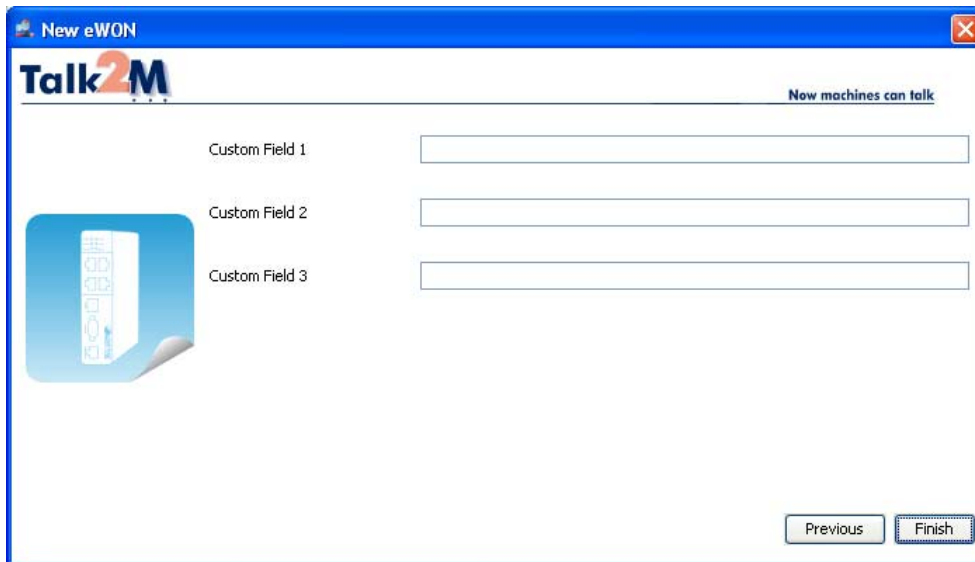

- In this window you have the possibility to enter custom fields such as the name of the customer or the order number. You may leave these fields empty or edit them later.
- Complete the entering with [Finish].
- Your TM router has been added to the device list.

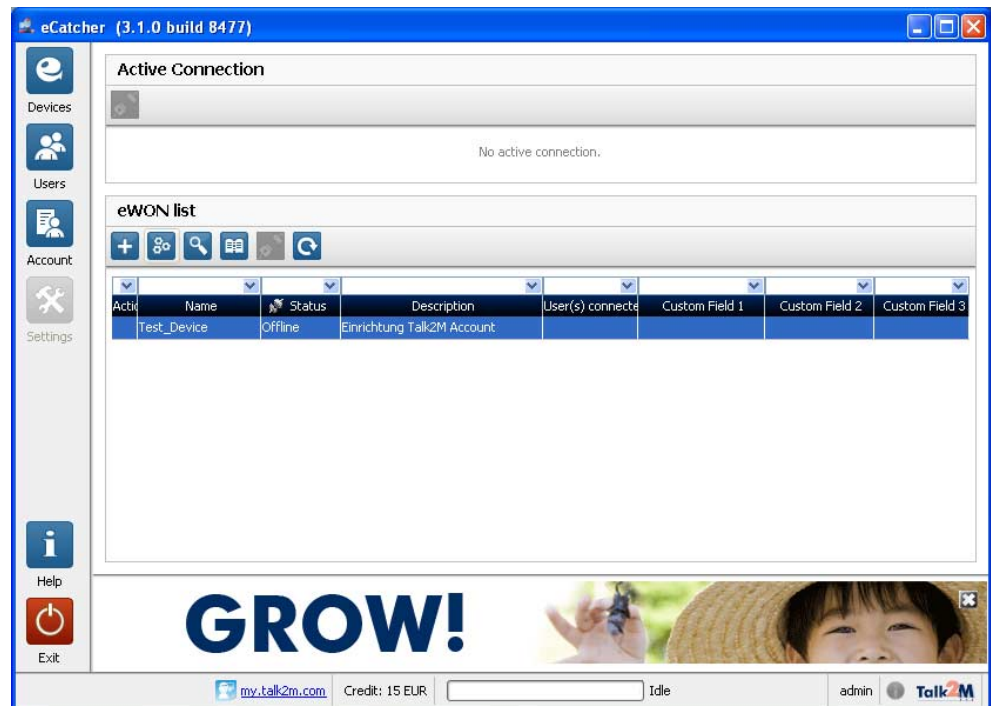

- Mark your Teleservice module and click .
- You can modify the setting in the following window.

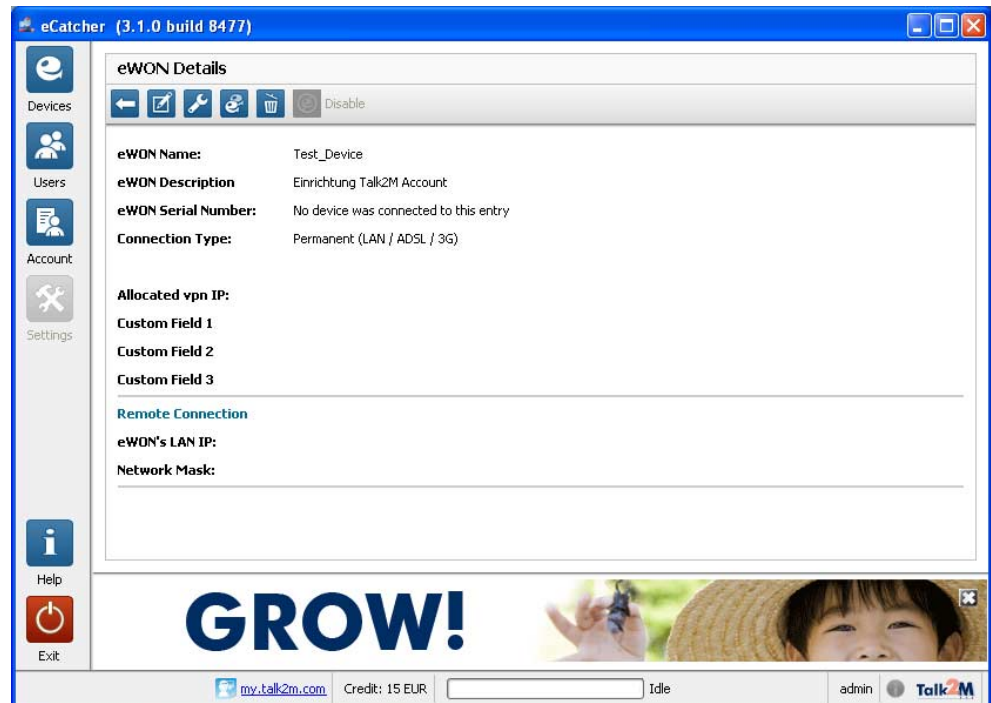

- Click  to continue with the activation of your Teleservice module.

- The following dialog window with an *Activation Key* opens.

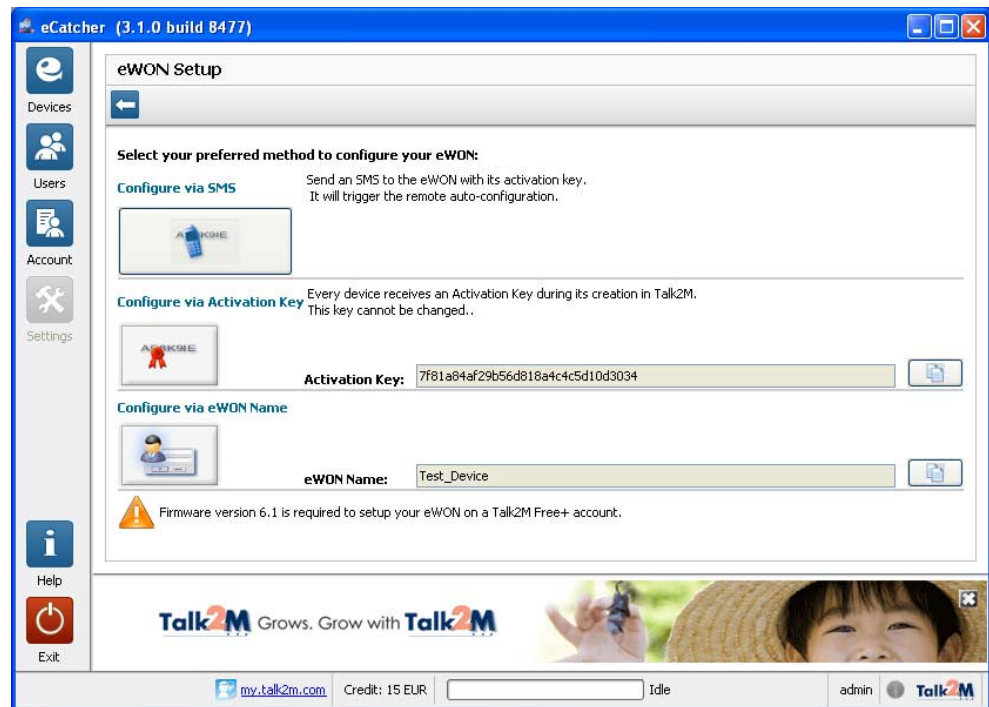

- Copy the *Activation Key* with [Copy] or  into clipboard respectively into a text file. This *Activation Key* is required at a later time.
- Log off and close eCatcher with .

Proceeding establishing TM connection for Talk2M

- Open the Web page of your TM by entering the LAN IP address of your Teleservice module into the address bar of your Internet browser. The default *username* and *password* are adm.

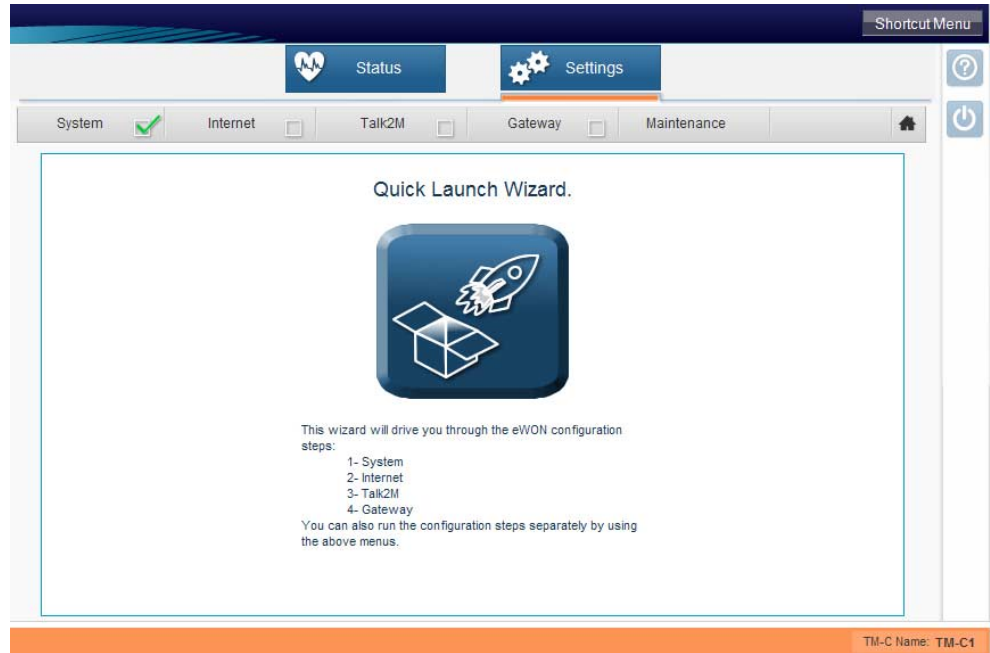

- In this window you have the possibility to start the easiest way of configuration by using the fast-start-assistant.
- Please enter your settings in the following window.

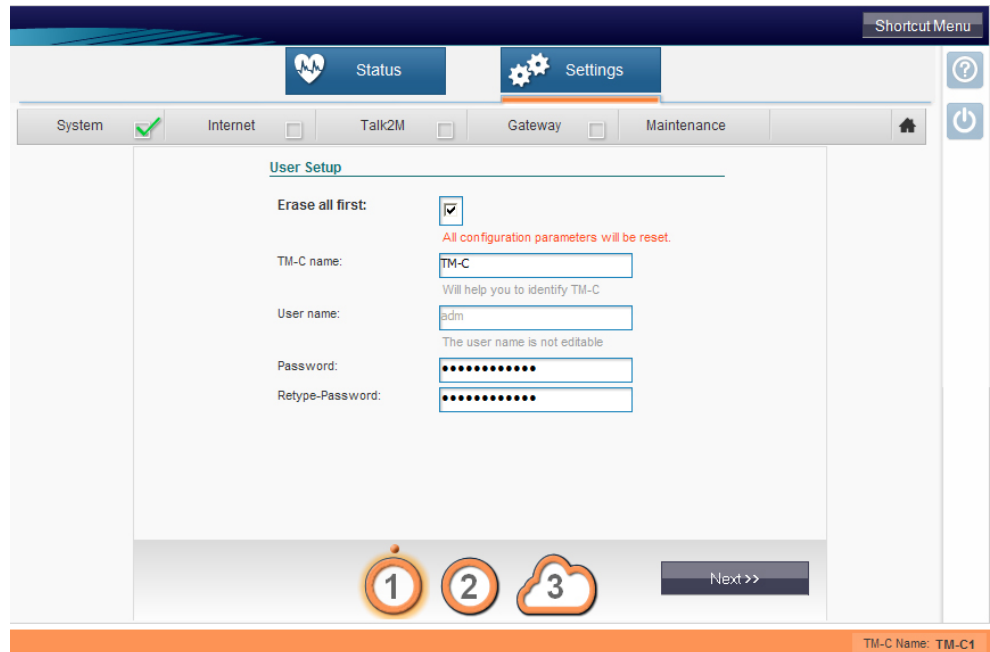

- Always check the box *Erase all first*. This also applies to a new TM.
- Enter the name of your TM. This is freely selectable. Next you have the possibility to change the password for the TM access.

- Confirm with [Next>>].

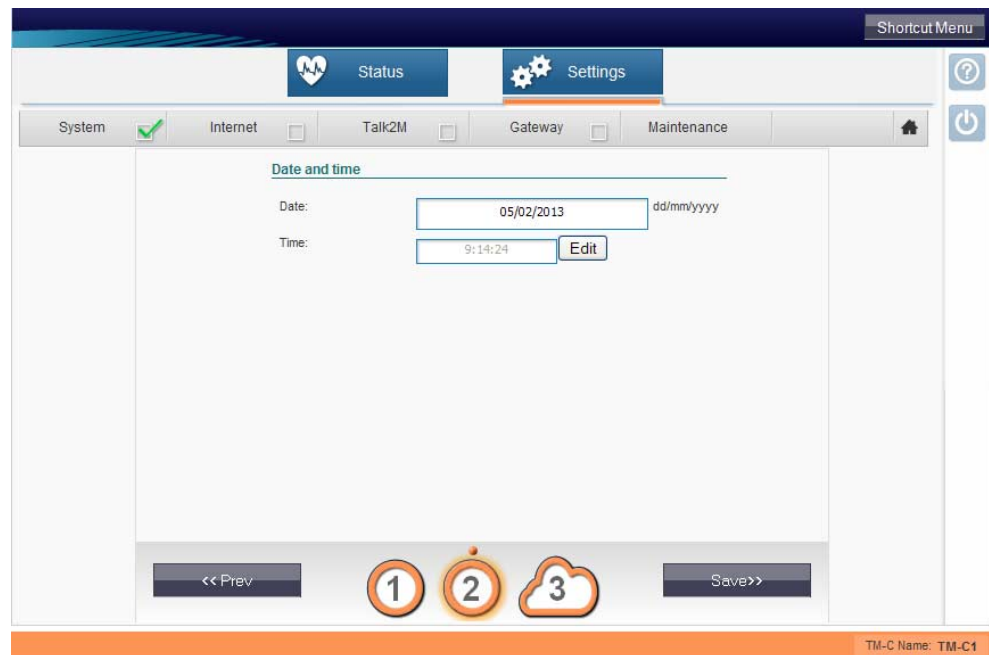

- Set time and date in the following window. If time and date are correct click [Save] otherwise click [Edit] to change the data.
- Existing data will be deleted and entered data of your TM will be set.

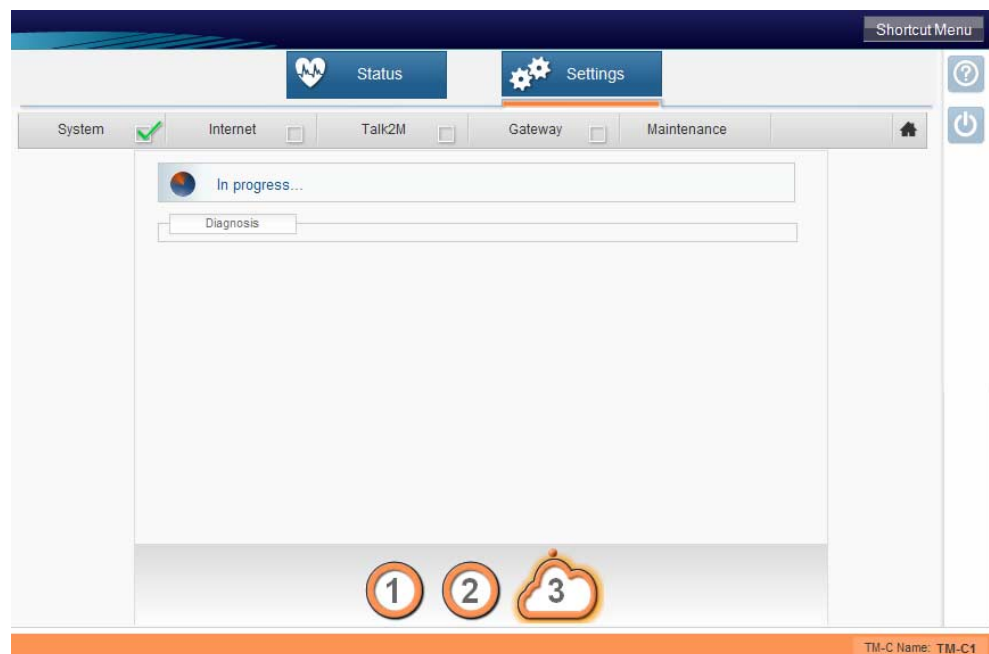

- If the data have been saved successfully, you will see the following window. For further configuration click [Next wizard>>].

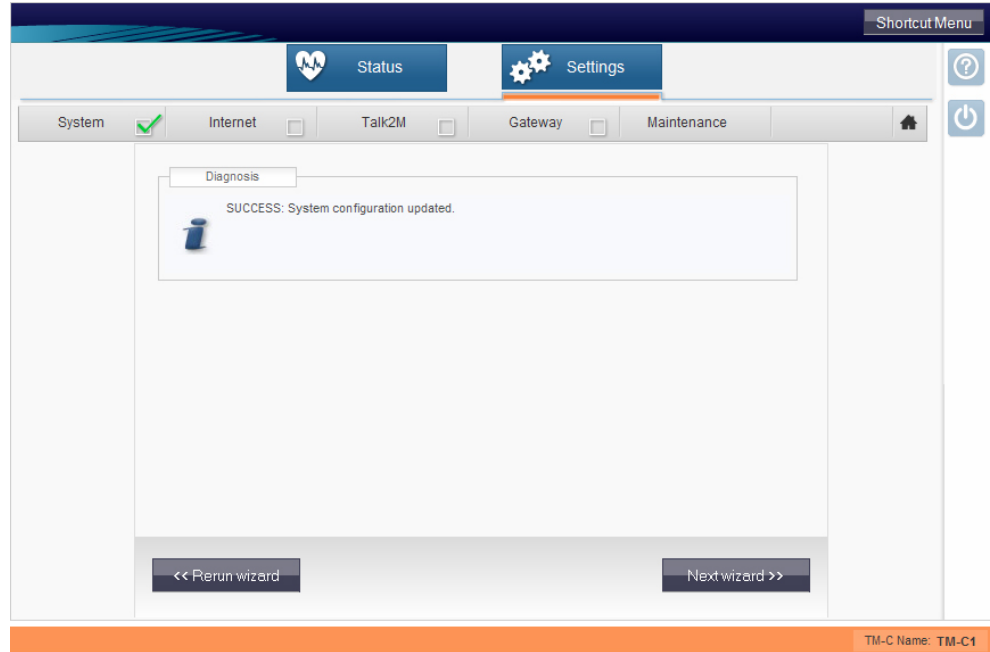

Proceeding configuration of the WAN connection

- Next you will be asked to configure the WAN connection. The WAN interface is marked with "INTERNET" and "Talk2M". Make sure that your WAN interface is connected to a ADSL-Router or a network by a network cable.
- Decide now when your TM should establish a connection. You have two choices:

Digital Input not used

The TM goes online as soon as it finds a working connection (standard release).

Digital Input HIGH needed to allow Internet Access

The TM goes online as soon as you set a signal for digital input.

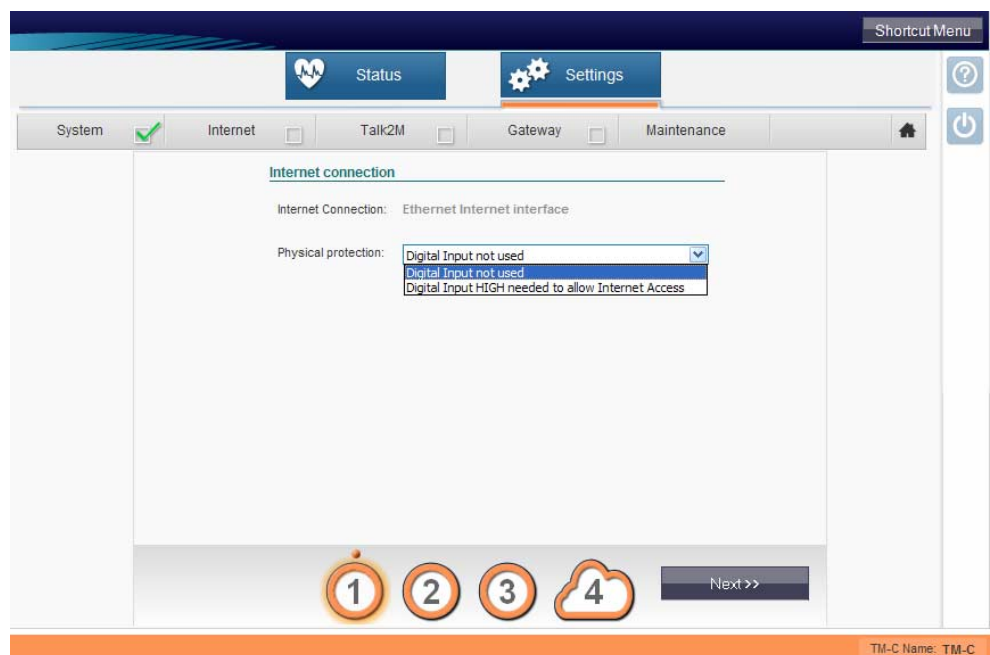

We recommend the first possibility, because you always have access to your system, even if the digital input is not able to be activated.

- Click [Next>>] to continue.
- At *Address settings* select "DHCP" for an automatic address allocation respectively "static" for a manual address allocation. Enter the corresponding IP address data, which the TM should have to the external side (WAN).

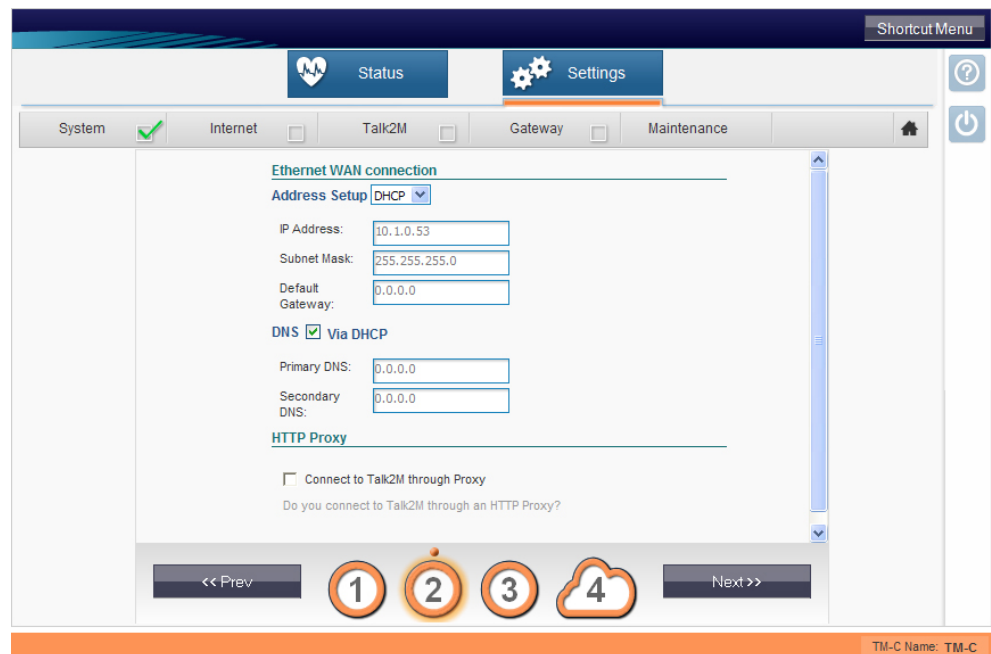

- Click [Next>>].
- Check of your settings are correct. Check the box *Test online address* and click [Test>>].

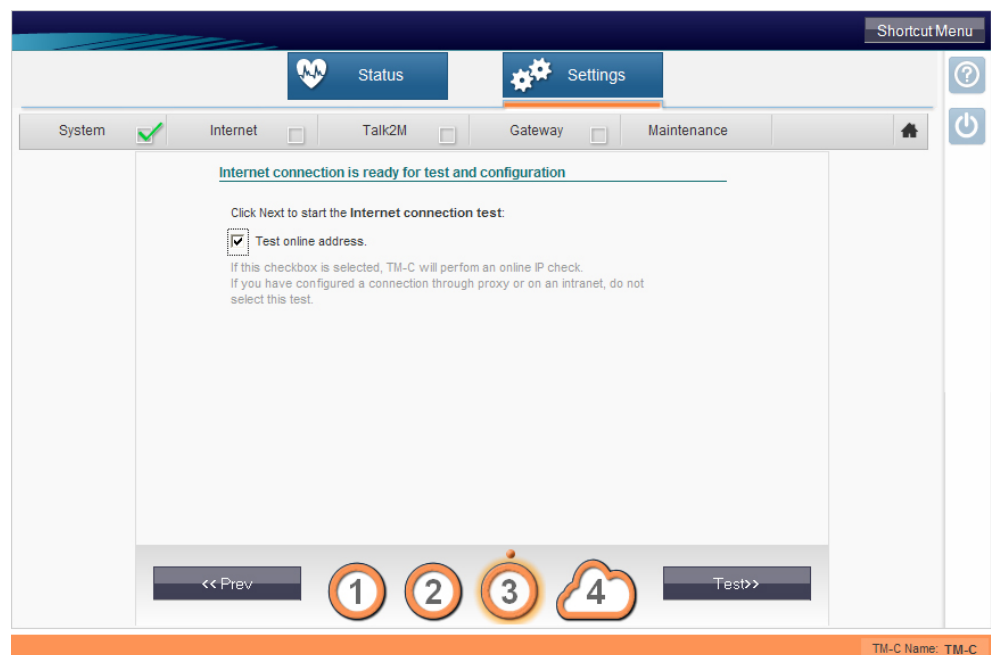

- A test of the WAN connection opens in the following window. Wait until the test is finished and the next window opens.

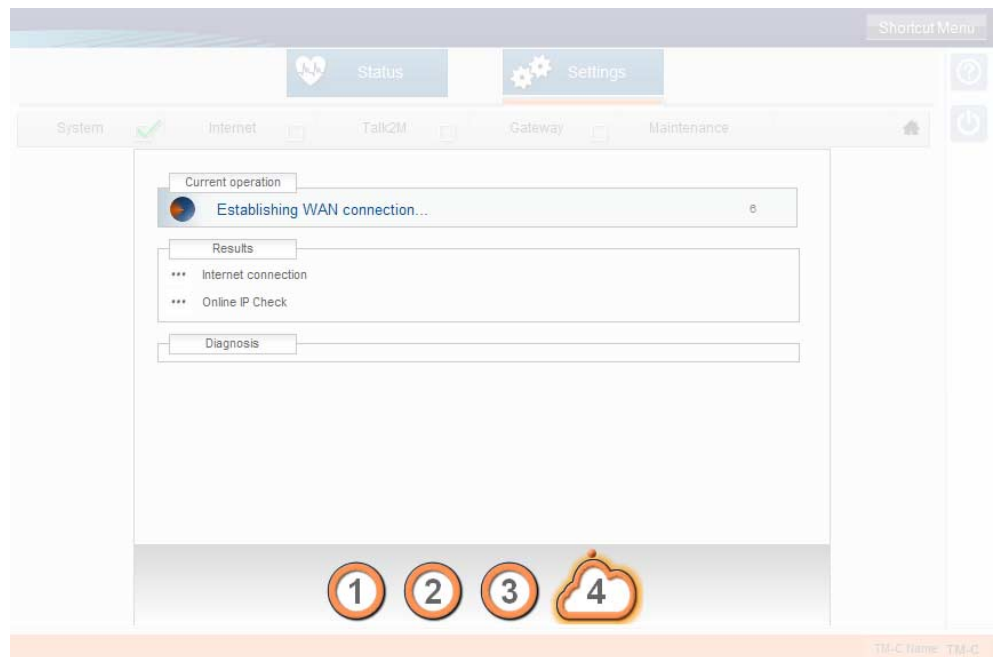

- If the test was successful, you will get a confirmation. Click [Next wizard>>] to register your TM on Talk2M-Account.

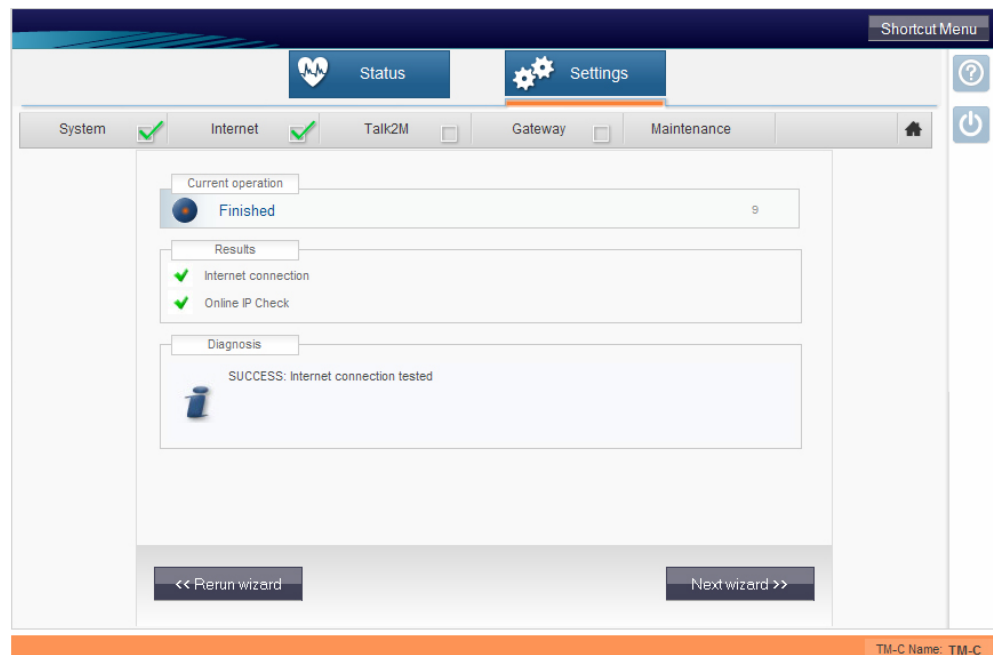

Proceeding configuration of the Talk2M connection

When the Internet connection was successfully established via WAN interface, you can register your TM on Talk2M-Account.

- Select *Register with activation key*.
- Paste the activation key, that you previously copied in the clipboard, in the Activation Key box.
- Click [Next wizard>>].

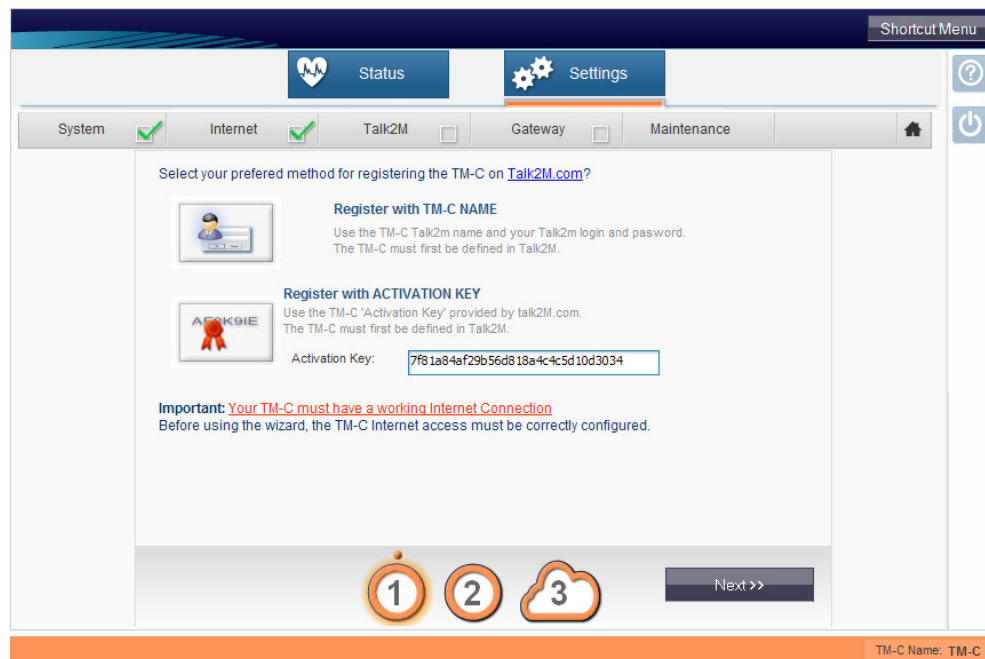

- If your Internet connection is established via HTTP Proxy, activate the following menu item. Click [Test>>] to confirm.

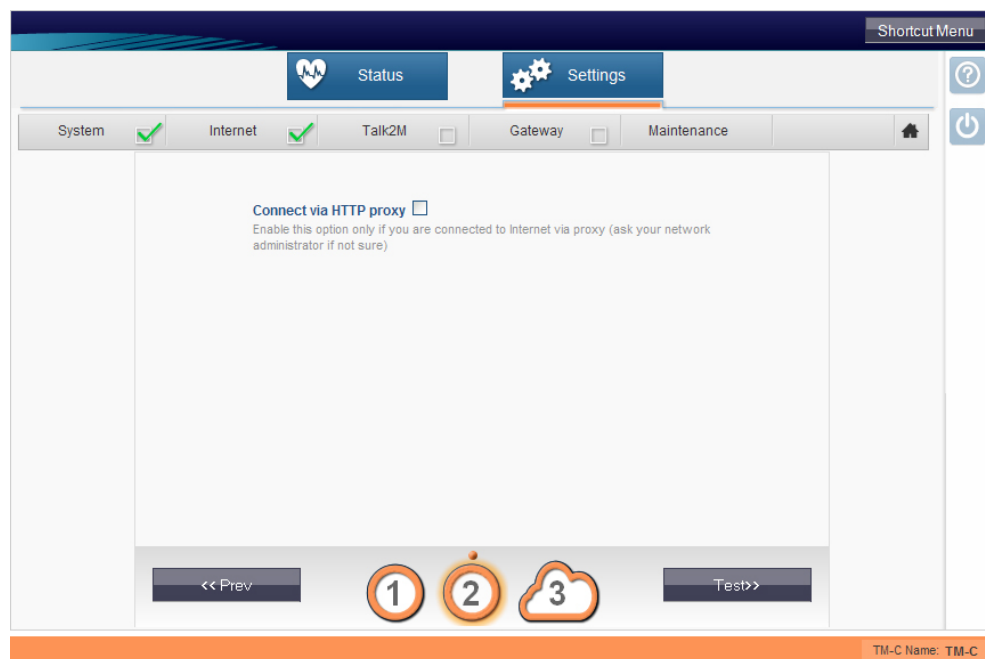

- Now your TM will establish a WAN connection to connect with the Talk2M-Server. This may take a moment.

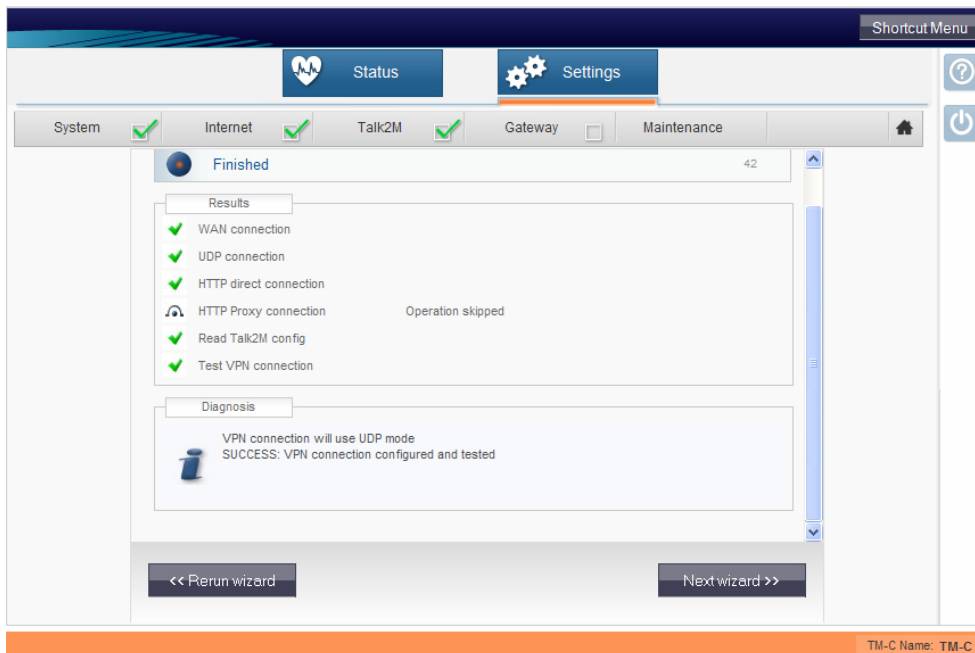

- If the diagnosis box reads: "SUCCESS: VPN connection configured and tested" your TM has registered successfully on Talk2M.
- Check if your TM is online. For that start the software eCatcher, log in with your access data and check the online status.

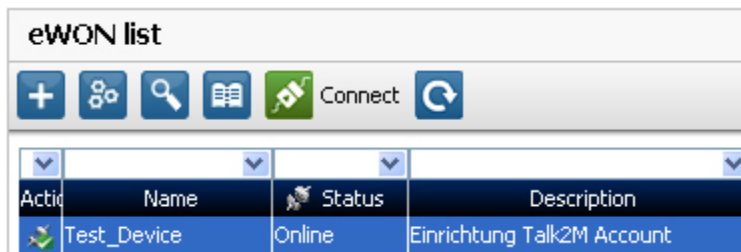

- Under "Status" your TM status should read: ONLINE. If your TM reads status: OFFLINE, check your settings, especially the IP addresses and contact your system administrator.

TM connection with components

TM connection with components via Ethernet

To reach your automation components (e.g. PLCs, Panels, IPCs, Web cams) via Ethernet, you do not have to configure your TM. The Ethernet Gateway and the Plug'n Route Feature are activated by default.

TM connection with components via MPI/PROFIBUS/PPI

To connect your automation components (e.g. PLCs) via MPI/PROFIBUS/PPI, you have to configure the gateway of your TM.

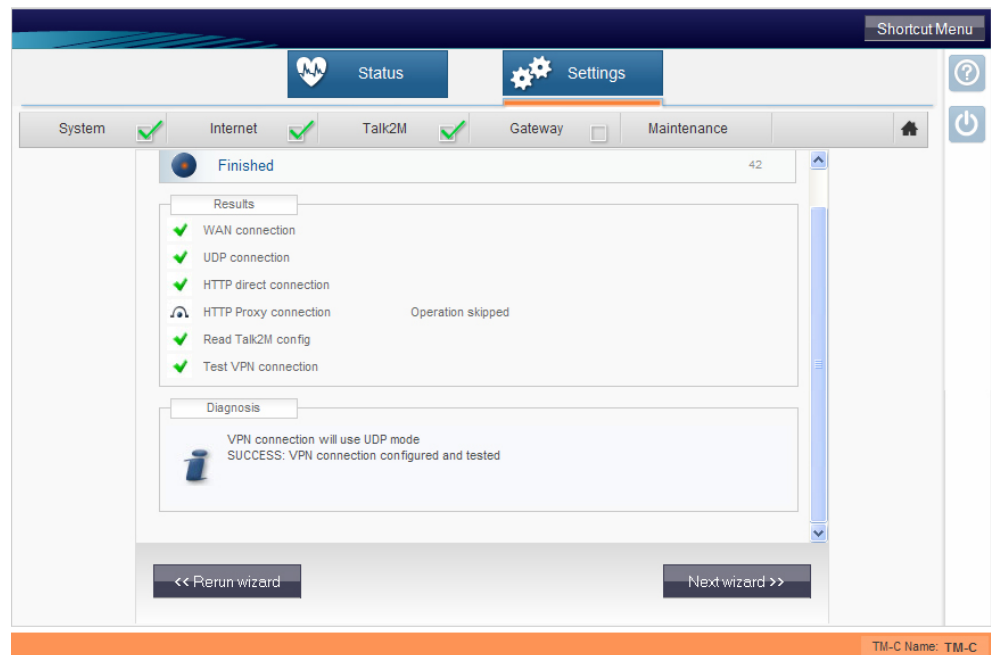

- For that click [Next wizard>>].

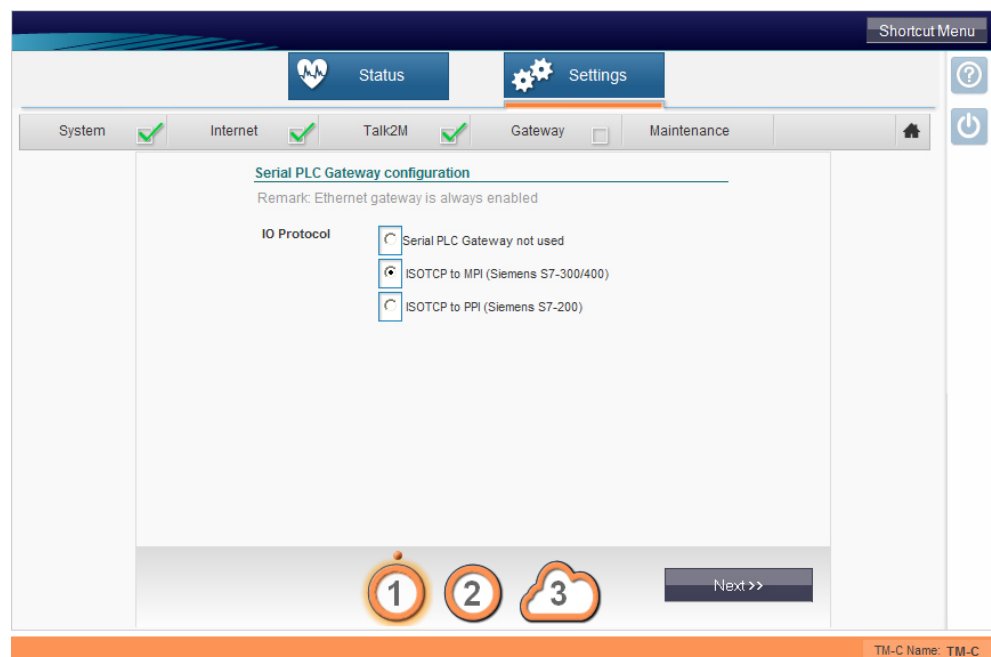

- Select the suitable IO protocol. In this case ISOTCP to MPI (Siemens S7-300/400) and click [Next>>].

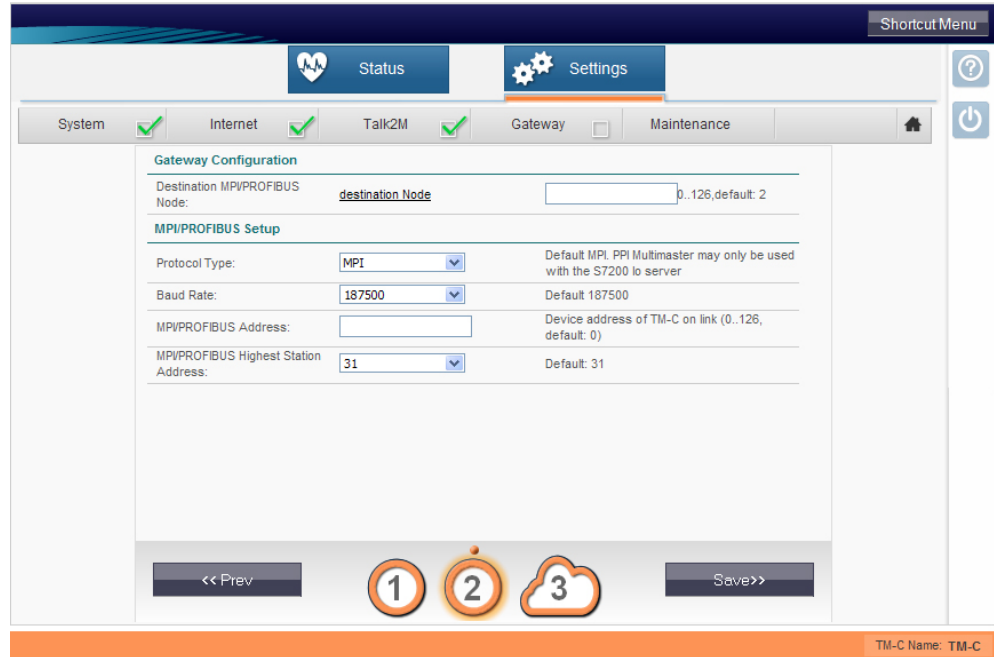

- Enter the communication settings of your PLC and select the used protocol. After that click [Save>>] to finish and to activate the gateway configuration.

Note!

You have the possibility, to see the connected MPI/PROFIBUS stations by clicking of *destination node*. This is not possible until you configure the protocol and the baud rate.

- After clicking [Save>>] you will receive the following message, that confirms your configuration was successful.

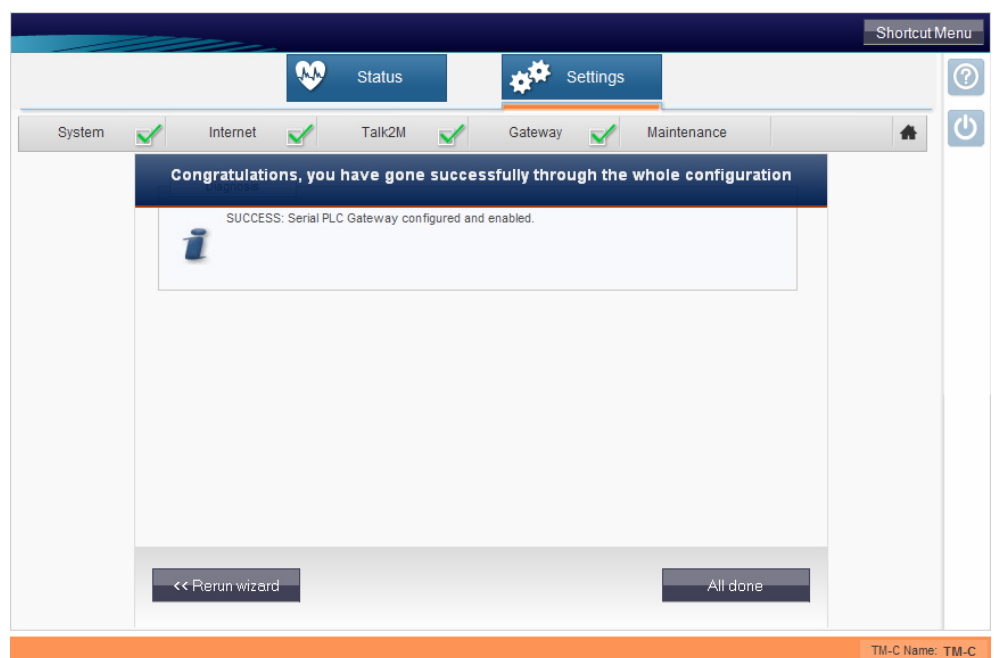

- Click [All done] to finish the configuration.

